

Serbian Cyrillic

Alphabet

32

9

1 Обој

A

3 Повежи

AC

4 Обоји слова

а е

Жж

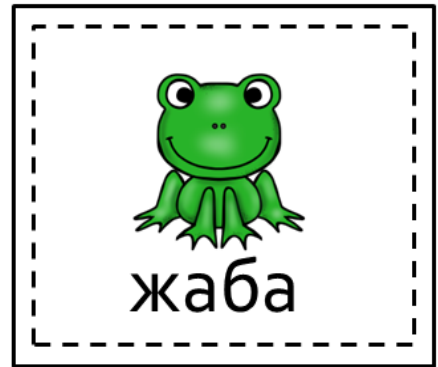

Жж

Handwriting practice lines for the letter Жж, consisting of multiple sets of solid top and bottom lines with a dashed middle line.



Serbian Cyrillic Alphabet includes 60 worksheets in color and 60 worksheets in black and white plus answer keys;

This set includes the following :

1. Serbian Cyrillic Alphabet chart (30 letters and 30 pictures for each letter)
2. Alphabet handwriting practice sheets (30 worksheets in color and 30 in black and white)
3. Letter ___ activity sheet (30 worksheets in color and 30 worksheets in black and white with 6 activities for each letter)

- a) Color the letter
- b) Write the missing letters
- c) Match (match the lowercase and the uppercase letters)
- d) Highlight the letter
- e) Number the letters (number the letters and put them in correct order)
- f) Circle the pictures that begin with letter ___

4. Serbian Cyrillic domino game

- 30 pieces of dominoes to practice alphabet in a super fun way. Black and white version is included;
- Students play the game by matching the letter and the picture

Happy learning !

Miss Jelena

1. Tabela cirilice (30 letters and 30 pictures for each letter)
2. Vezba pisanja slova cirilice (30 worksheets in color and 30 in black and white)
3. Vezbanja sa 6 razlicitih aktivnosti za svako slovo (30 worksheets in color and 30 worksheets in black and white)

- a) Oboj slovo ____
- b) Dopisi slova koja nedostaju
- c) Povezi malo i veliko slovo
- d) Pronadji i oboj slovo ____
- e) Poredjaj i obelezi slova brojevima 1,2,3
- f) Zaokruzi sve sto pocinje na slovo ____











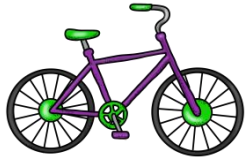







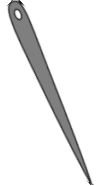



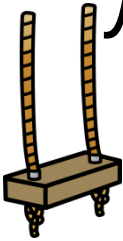

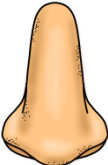



4. Domino igra

- 30 domino kartica u boji za ucenje cirilice na zabavan nacin.
- Djaci igraju igru tako sto povezuju slovo i slicicu;

Happy learning !

Miss Jelena

А З Б У К А

<p>Аа</p> 	<p>Бб</p> 	<p>Вв</p> 	<p>Гг</p> 	<p>Дд</p> 
<p>Ђђ</p> 	<p>Ее</p> 	<p>Жж</p> 	<p>Зз</p> 	<p>Ии</p> 
<p>Јј</p> 	<p>Кк</p> 	<p>Лл</p> 	<p>Љљ</p> 	<p>Мм</p> 
<p>Нн</p> 	<p>Њњ</p> 	<p>Оо</p> 	<p>Пп</p> 	<p>Рр</p> 
<p>Сс</p> 	<p>Тт</p> 	<p>Ђђ</p> 	<p>Уу</p> 	<p>Фф</p> 
<p>Хх</p> 	<p>Цц</p> 	<p>Чч</p> 	<p>Џџ</p> 	<p>Шш</p> 

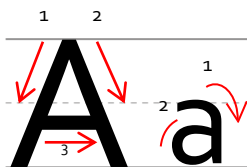
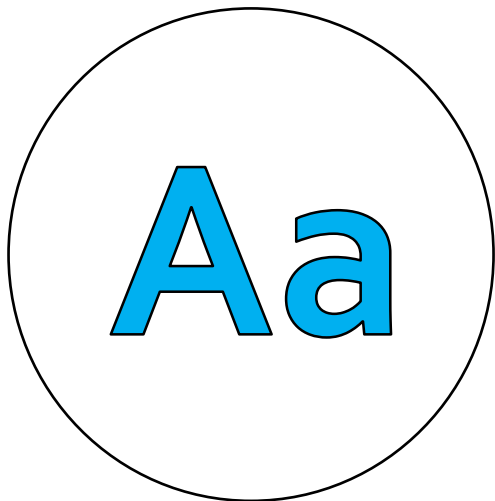

Handwriting practice lines consisting of four sets of horizontal lines. Each set includes a solid top line, a dashed middle line, and a solid bottom line. The first set is pre-filled with the letter 'Aa' and its stroke order arrows, while the remaining three sets are blank for practice.

Бб



Б б

Handwriting practice lines consisting of four sets of horizontal lines (top, middle dashed, bottom) for practicing the Cyrillic letters Б and б.

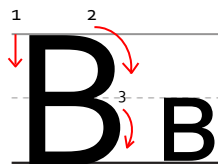
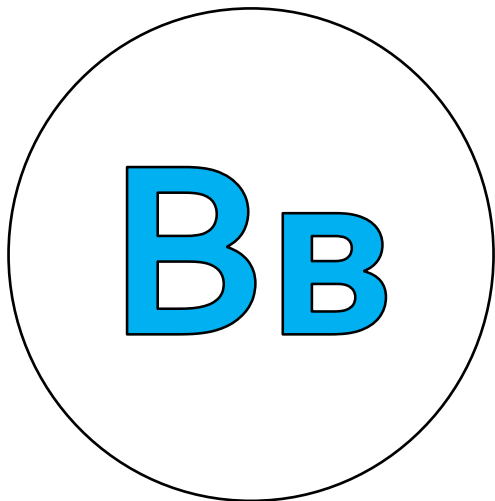

Handwriting practice lines consisting of multiple sets of horizontal lines (top, middle dashed, bottom) for practicing the letter 'В'.

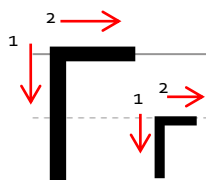
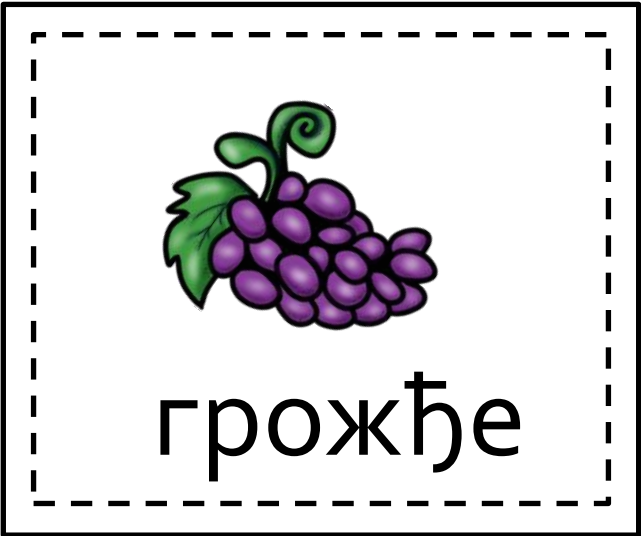
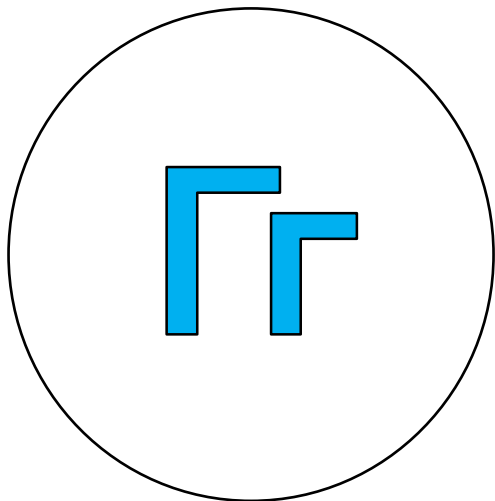

Handwriting practice lines consisting of multiple sets of horizontal lines. Each set includes a solid top line, a dashed middle line, and a solid bottom line. The first set includes the tracing guide for the letter 'Гг'.

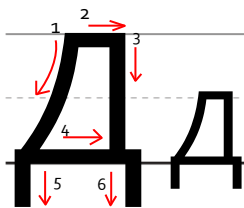
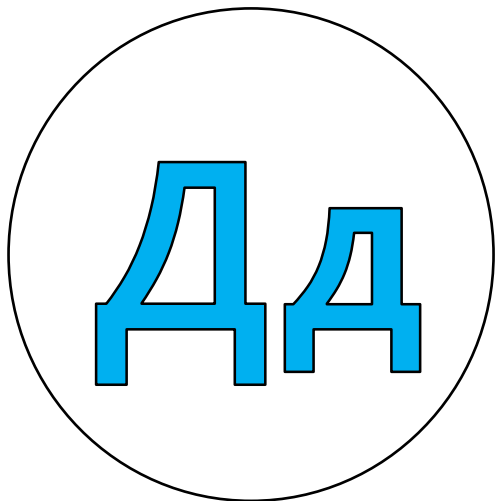

Handwriting practice lines consisting of multiple sets of horizontal lines (top, middle dashed, bottom) for practicing the letter 'Д'.

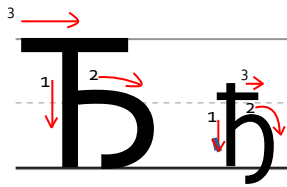
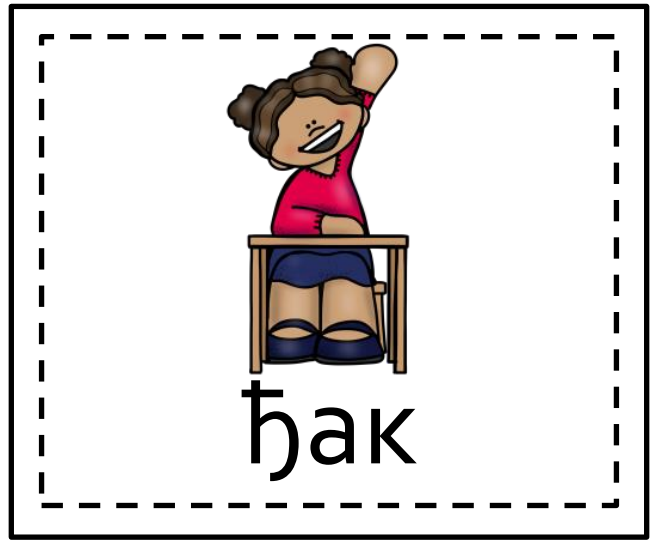

Handwriting practice lines consisting of multiple sets of three horizontal lines (top, middle-dashed, bottom) for practicing the Cyrillic letters 'Ѡ' and 'ѡ'.

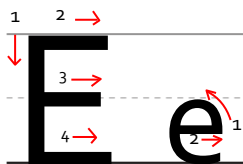
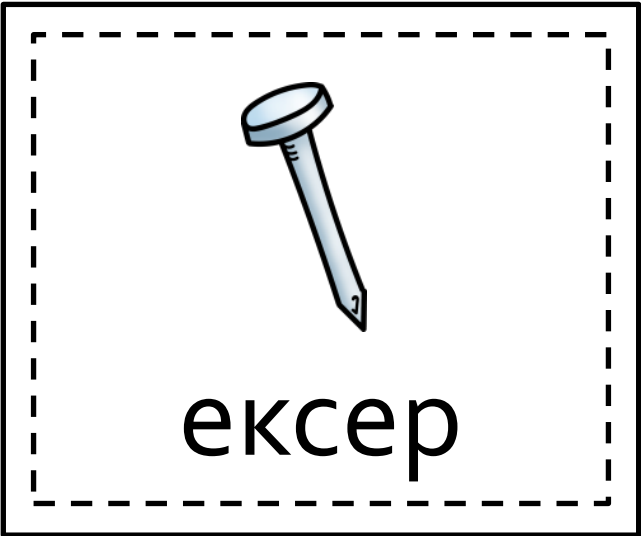
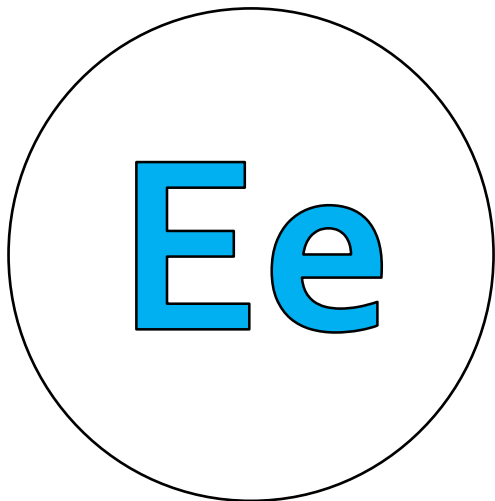

Handwriting practice lines consisting of four sets of horizontal lines. Each set includes a solid top line, a dashed middle line, and a solid bottom line. The first set contains the tracing guide for 'E' and 'e', while the remaining three sets are blank for practice.

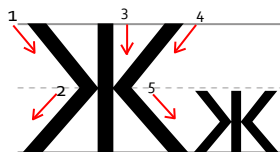
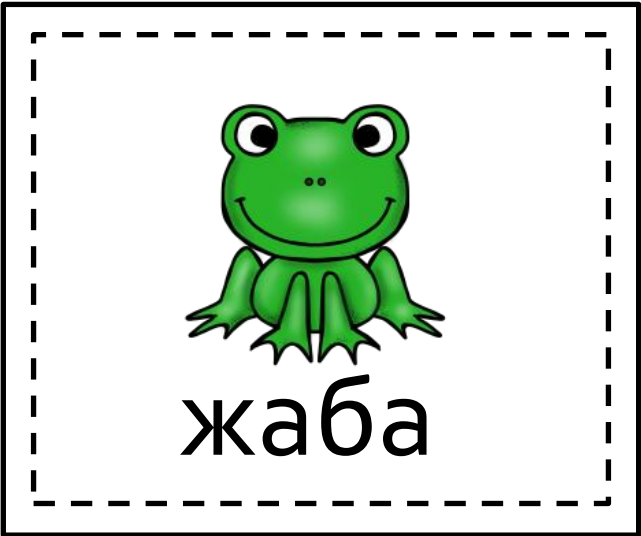
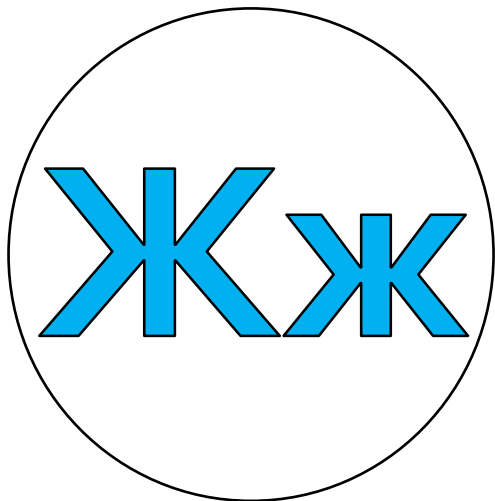

Handwriting practice lines consisting of multiple sets of horizontal lines (top, middle dashed, bottom) for practicing the letter 'Ж'.

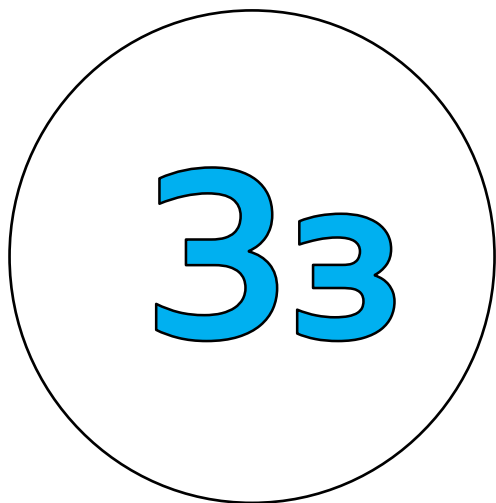

З з

A tracing guide for the Cyrillic letter 'З'. The uppercase 'З' is shown on a set of three horizontal lines (top, middle-dashed, bottom). Red arrows and numbers indicate the stroke order: '1' with an arrow pointing right across the top, and '2' with an arrow pointing down and then curving back up to the right.

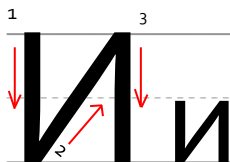
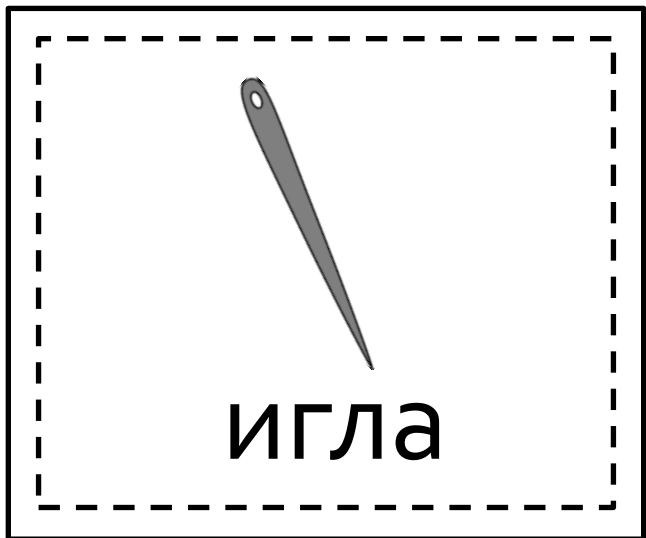
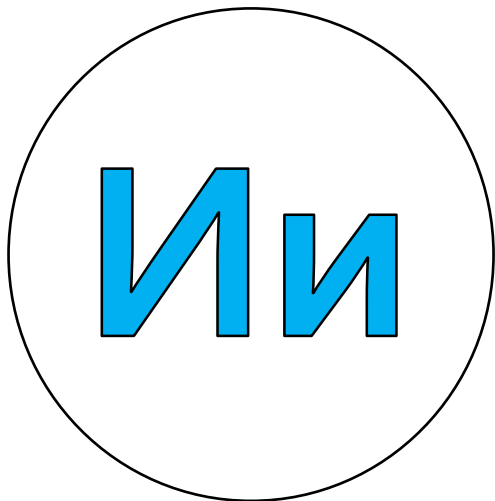

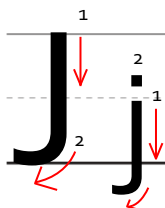
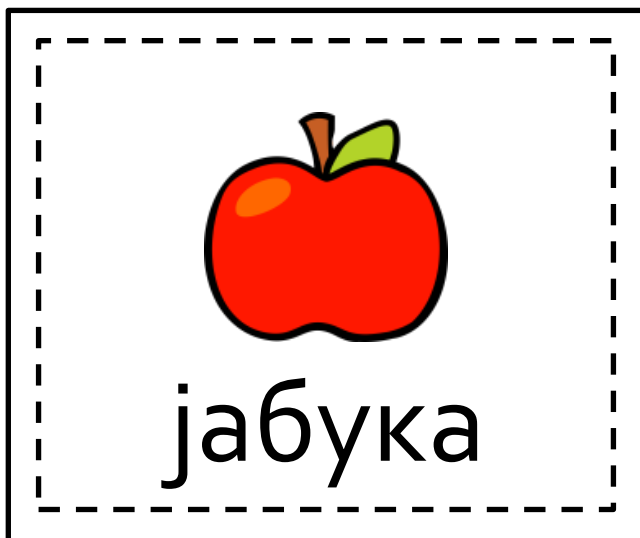
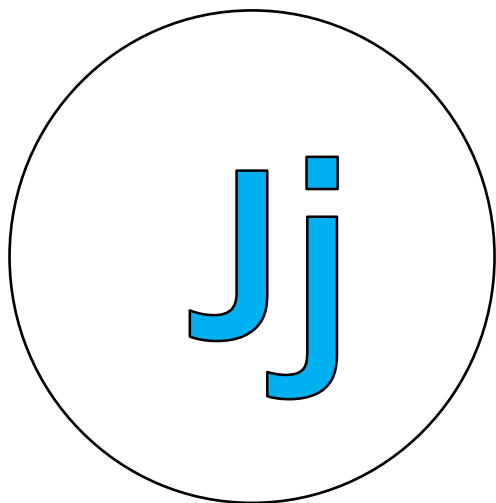

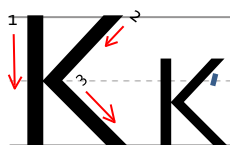
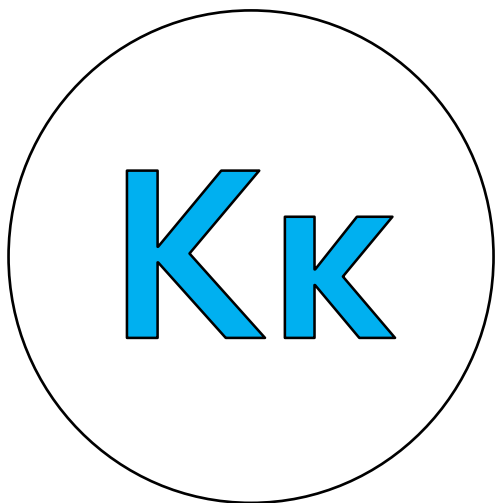

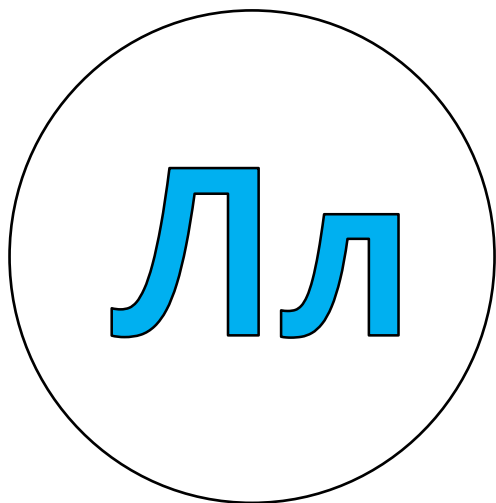

лопта

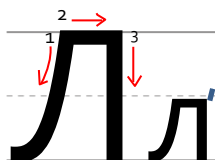

Льль

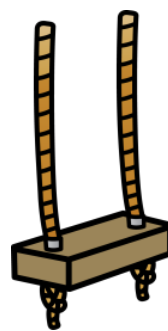

љуљашка

Лљ лљ

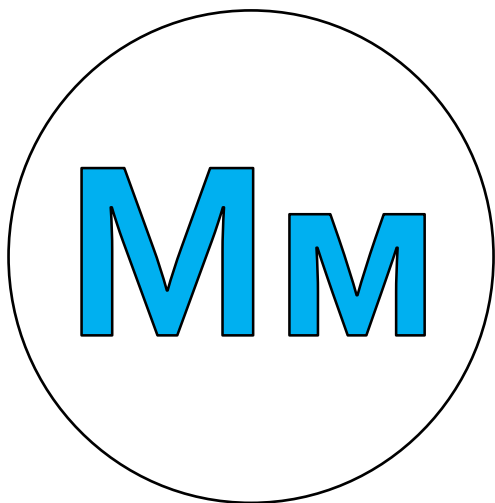

мајмун

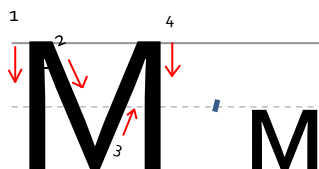

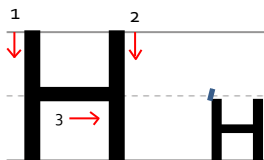
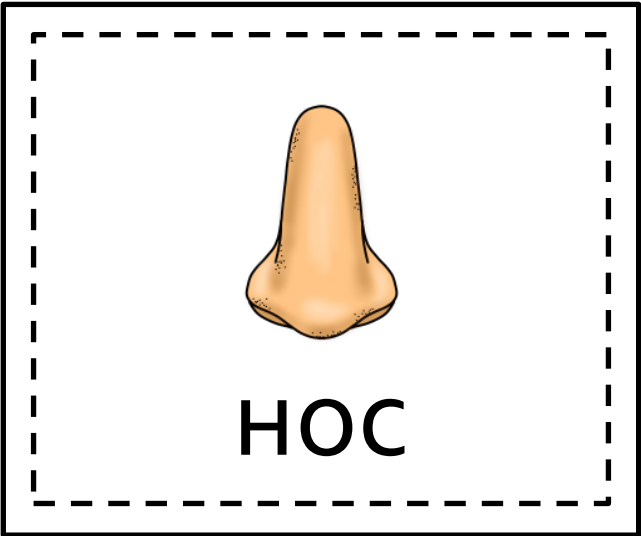
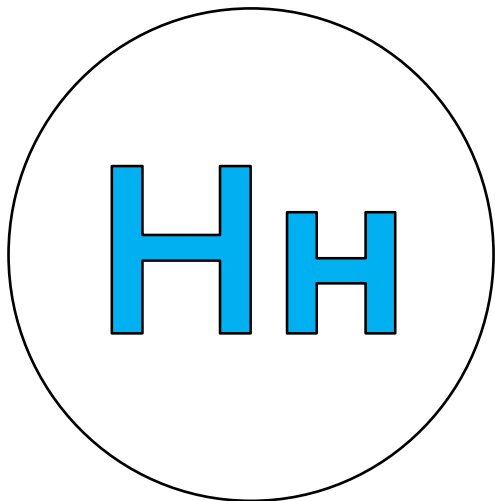

Handwriting practice lines consisting of multiple sets of four horizontal lines (top, middle-dashed, bottom, and baseline).

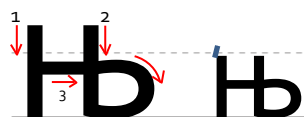
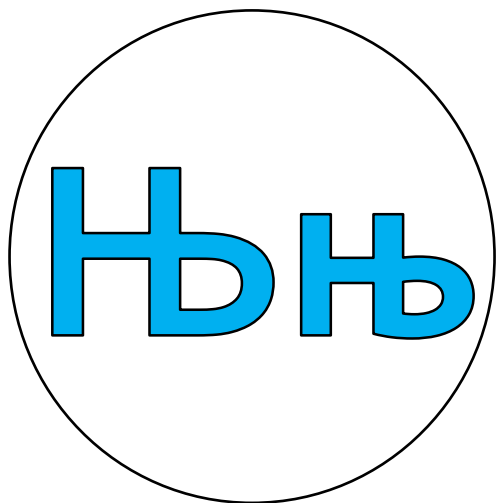

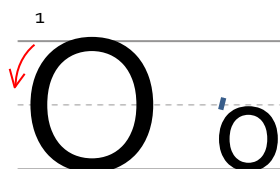
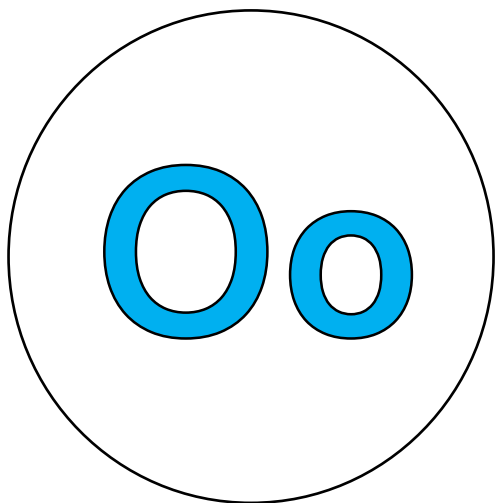

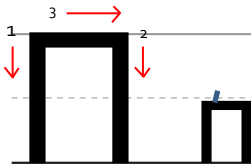
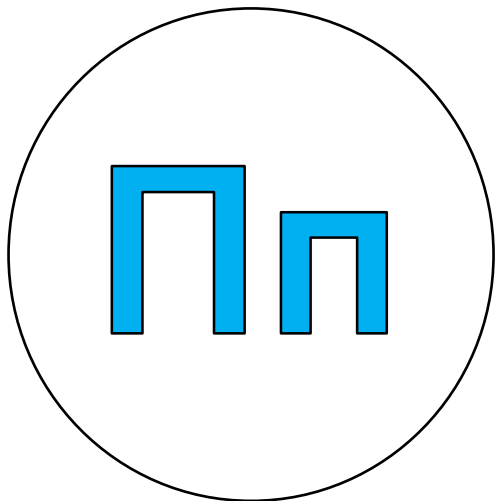

Handwriting practice lines consisting of multiple sets of four horizontal lines (top, middle-dashed, bottom, and baseline).

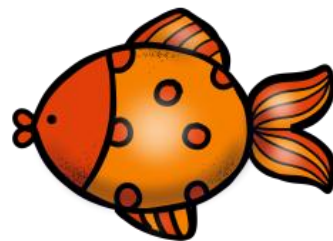
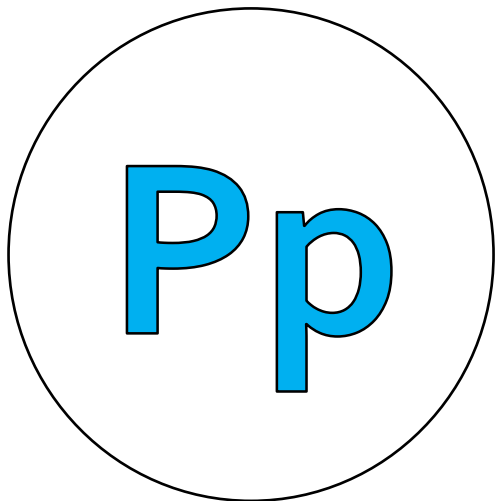

риба

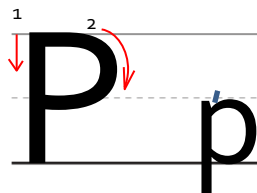

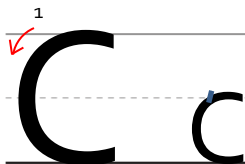
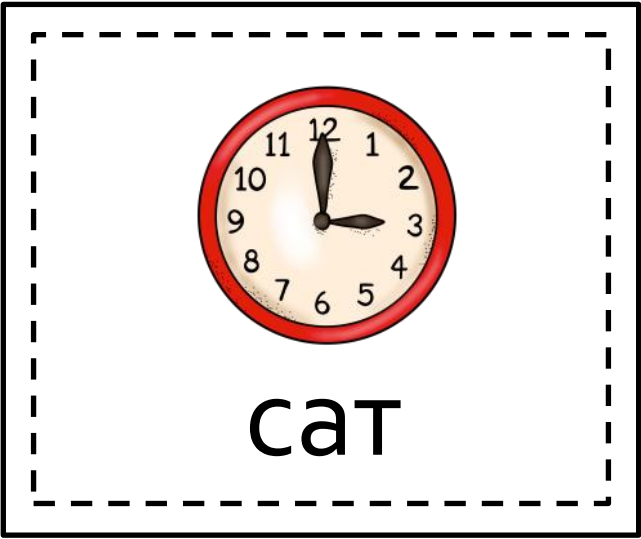
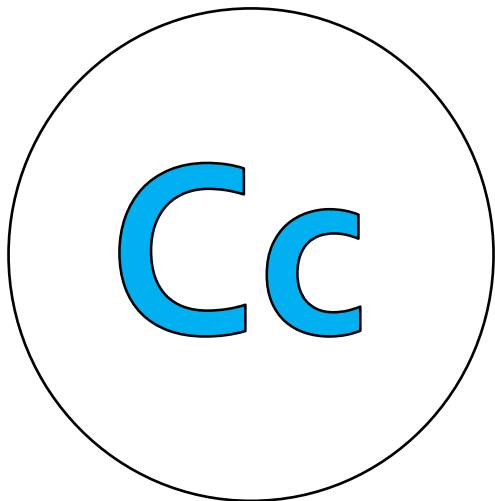

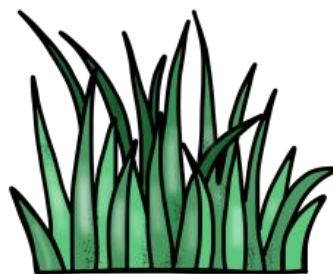
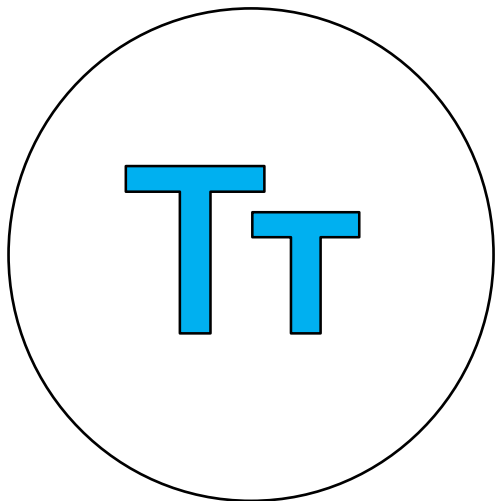

Трава

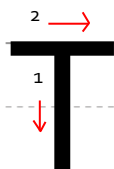

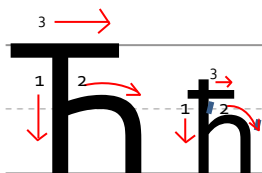
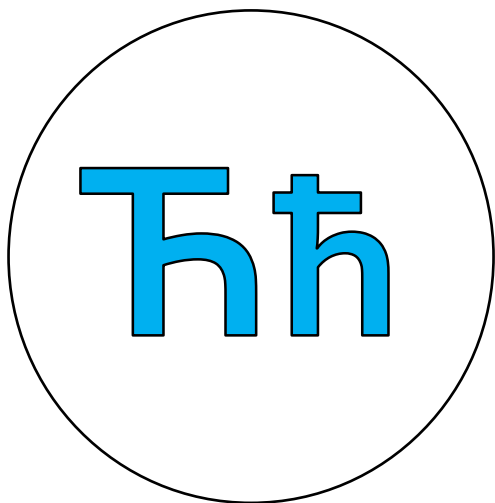

Handwriting practice lines consisting of multiple sets of three horizontal lines (top, middle-dashed, bottom) for writing practice.

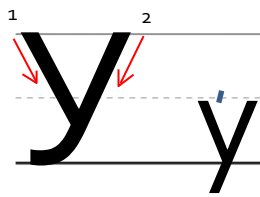
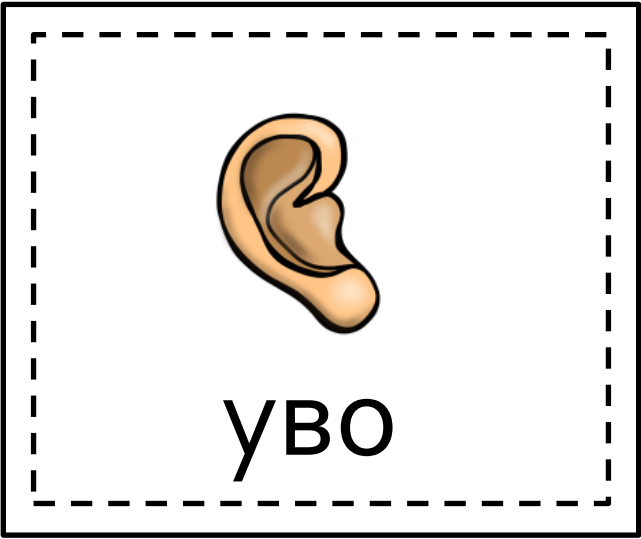
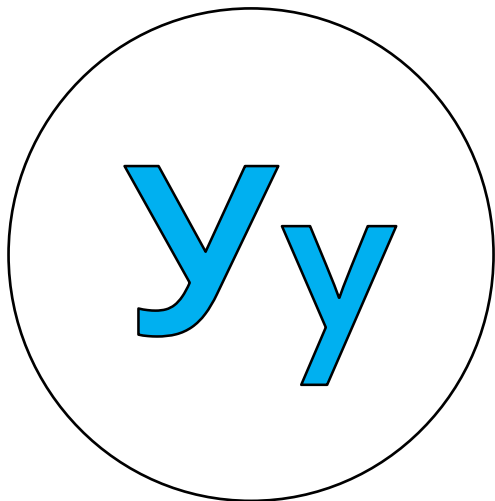

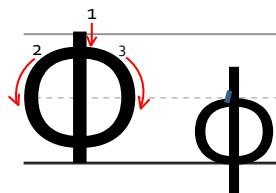
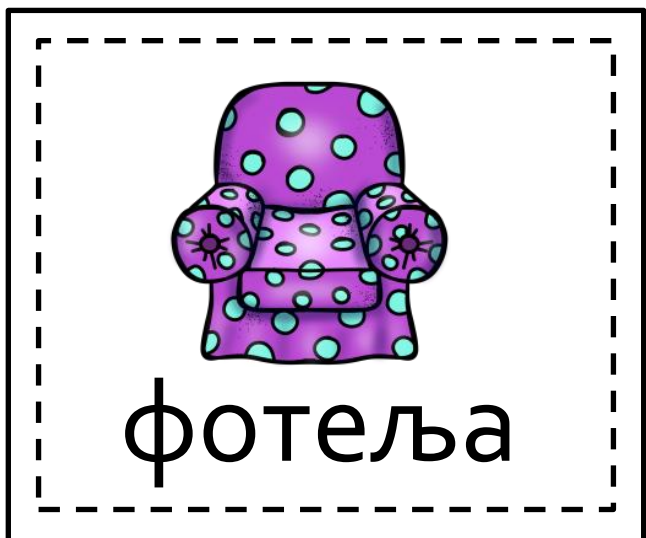
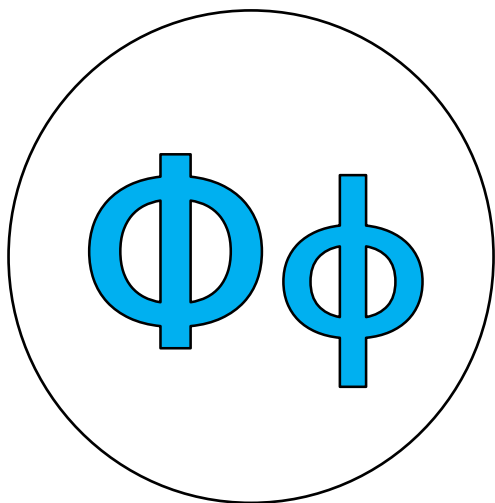

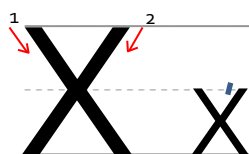
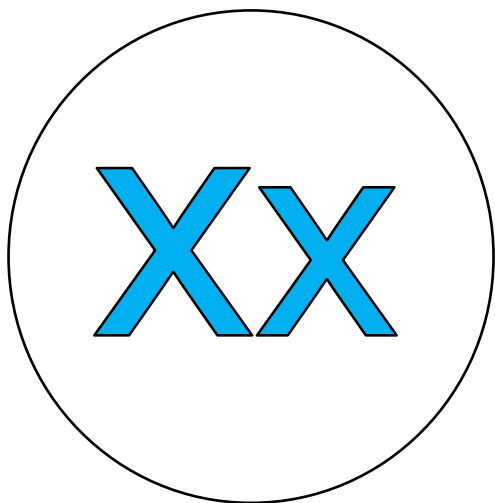

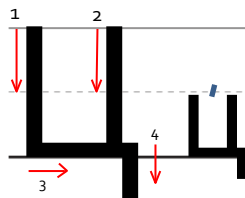
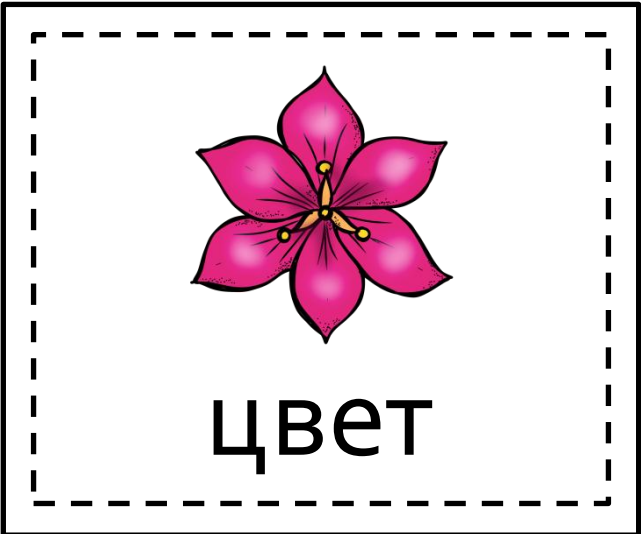
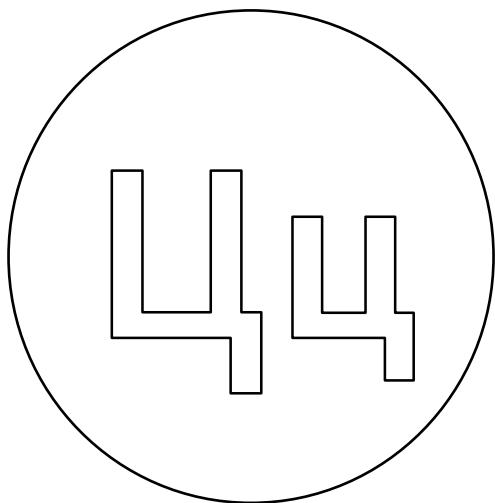

Handwriting practice lines consisting of multiple sets of three horizontal lines (top, middle-dashed, bottom) for practicing the letter 'Ц'.

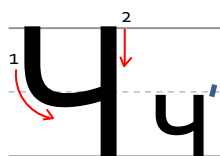
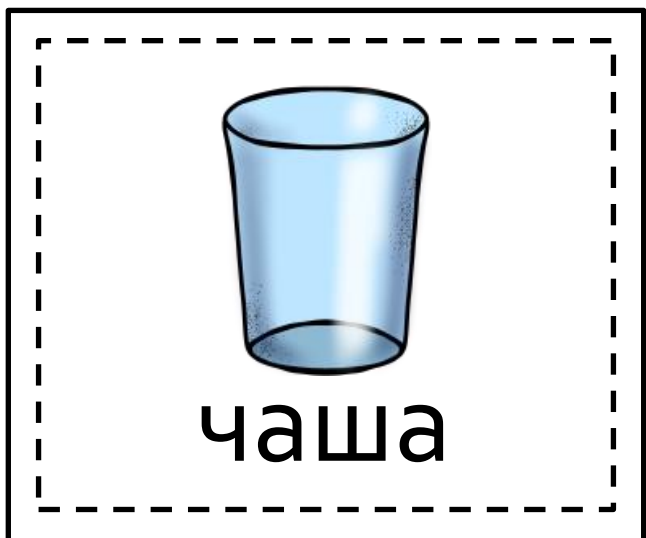
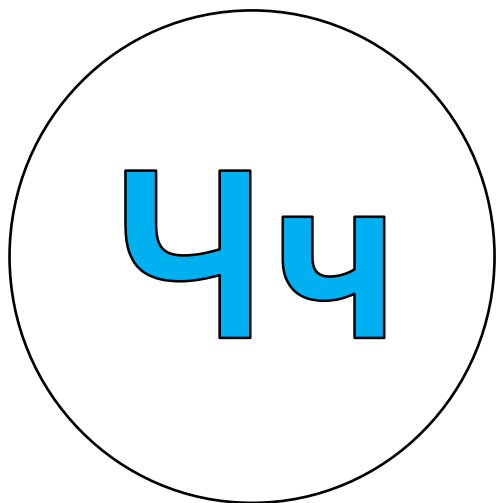

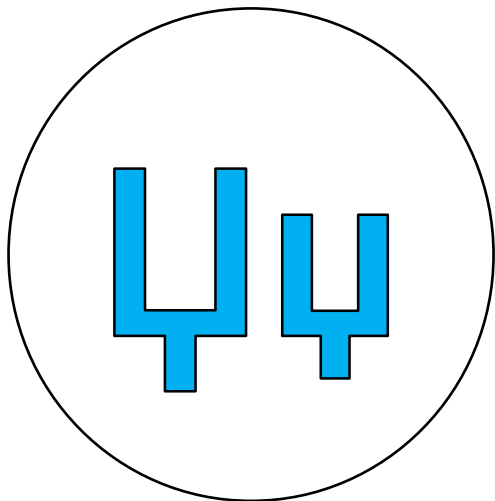

цeмпep

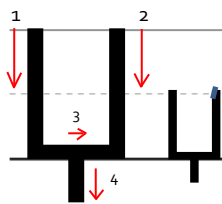

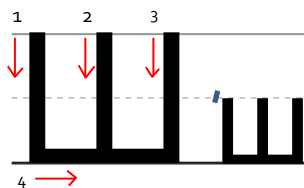
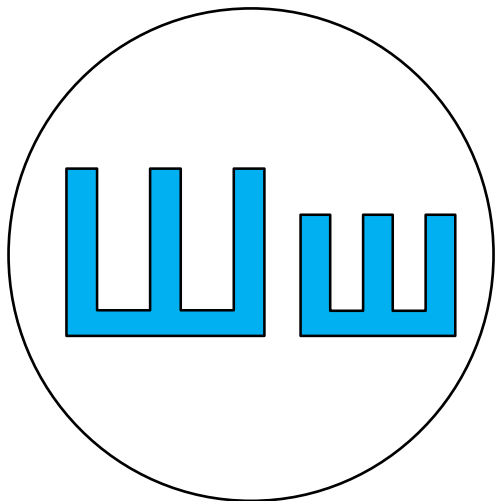

1 Обој

Aa

2 Допиши слово које недостаје

A		B
---	--	---

	Б	В
--	---	---

A	Б	
---	---	--

3 Повежи

A	C
---	---

e

c

a

4 Обоји слово а

а	е	с	а
е	а	а	с
с	а	е	а

6 Заокружи све што почиње на слово а



5 Означи бројевима 1,2,3

Vv	Aa	Bb

1 Обој

Бб

2 Допиши слово које недостаје

А	Б	
---	---	--

3 Повежи

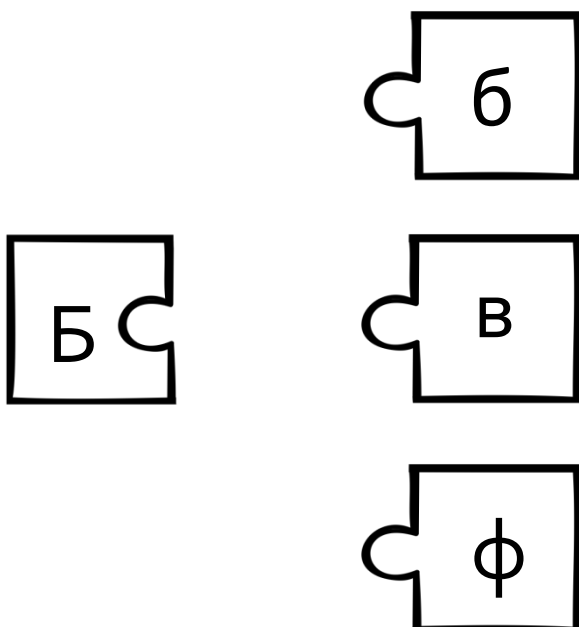

А		В
---	--	---

	Б	В
--	---	---

4 Обој слово б

б	р	б	ф
ф	б	б	р
б	ф	р	б

6 Заокружи све што почиње на слово б

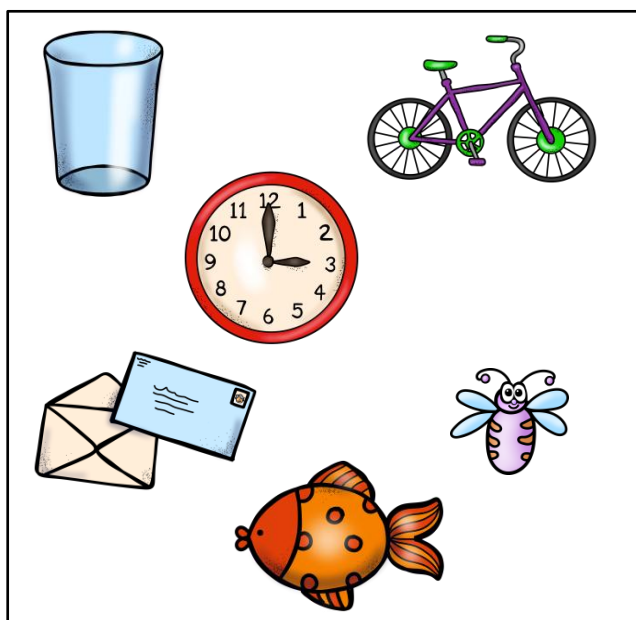

5 Означи бројевима 1,2,3

Бб	Аа	Вв

1 Обој

В В

2 Допиши слово које недостаје

Б		Г
---	--	---

	В	Г
--	---	---

Б	В	
---	---	--

3 Повежи

В	С
---	---

О

В

б

4 Обој слово в

б	в	в	б
ф	в	ф	в
в	б	в	в

6 Заокружи све што почиње на слово в



5 Означи бројевима 1,2,3

Бб	Вв	Аа

1 Обој

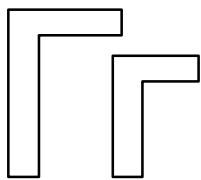

2 Допиши слово које недостаје

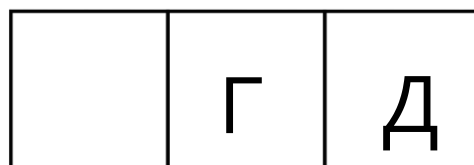
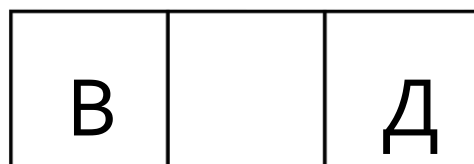
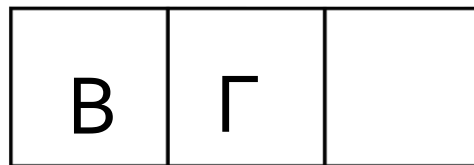

3 Повежи

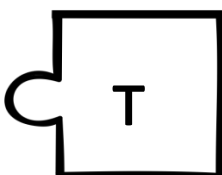
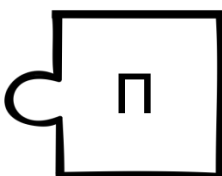
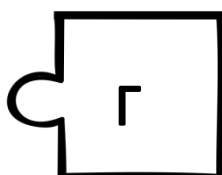
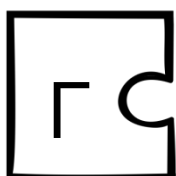

4 Обој слово г

Т	Г	Т	Г
Г	Т	Т	Г
Г	Г	Т	Т

5 Означи бројевима 1,2,3

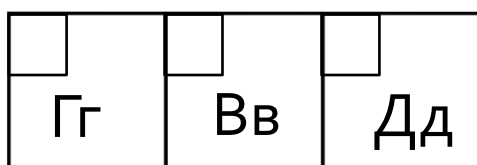

6 Заокружи све што почиње на слово г

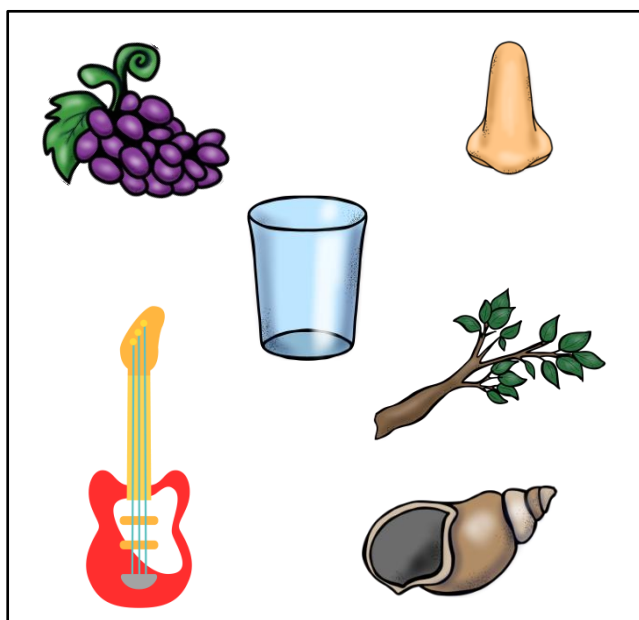

1 Обој

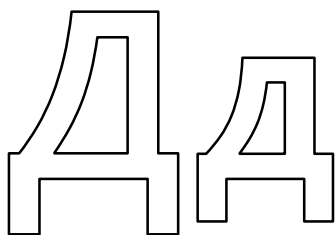

2 Допиши слово које недостаје

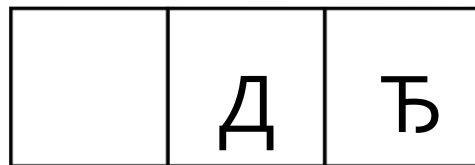

3 Повежи

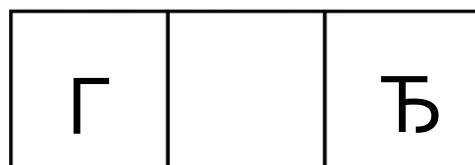
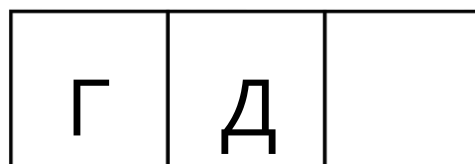
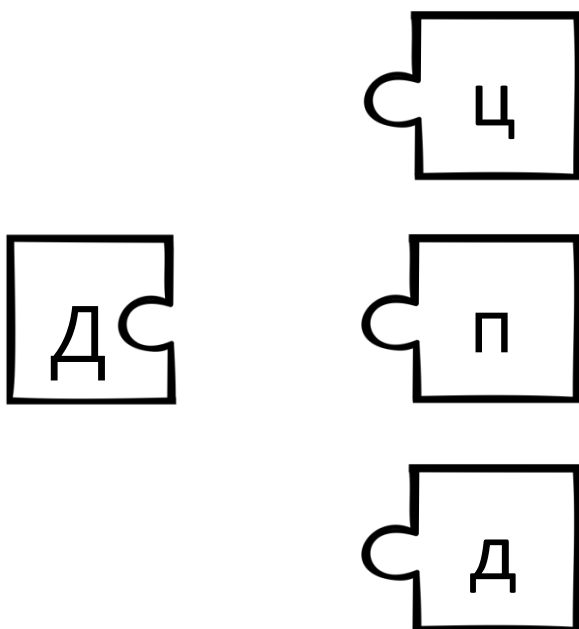

4 Обој слово д

д	ц	д	ц
ц	ц	д	ц
д	ц	д	ц

6 Заокружи све што почиње на слово д



5 Означи бројевима 1,2,3

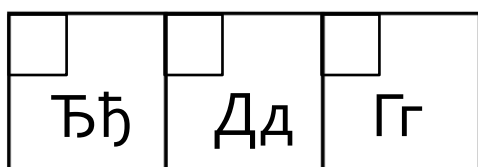

1 Обој

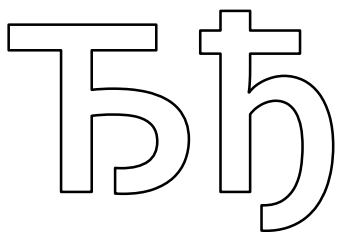

2 Допиши слово које недостаје

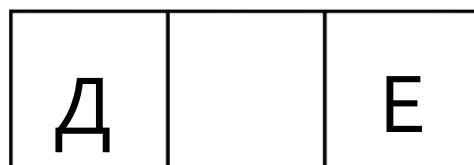
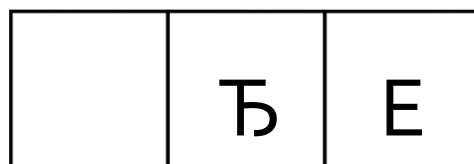
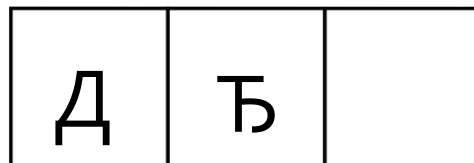

3 Повежи

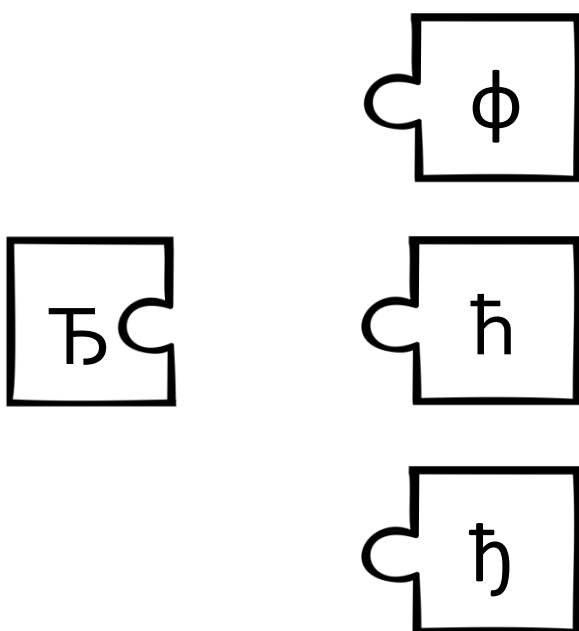

4 Обој слово ћ

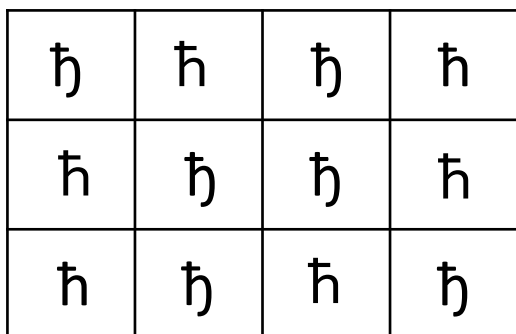

5 Означи бројевима 1,2,3

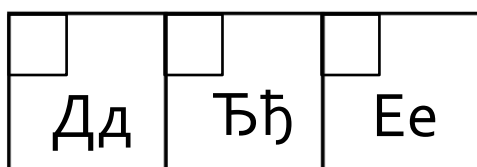

6 Заокружи све што почиње на слово ћ

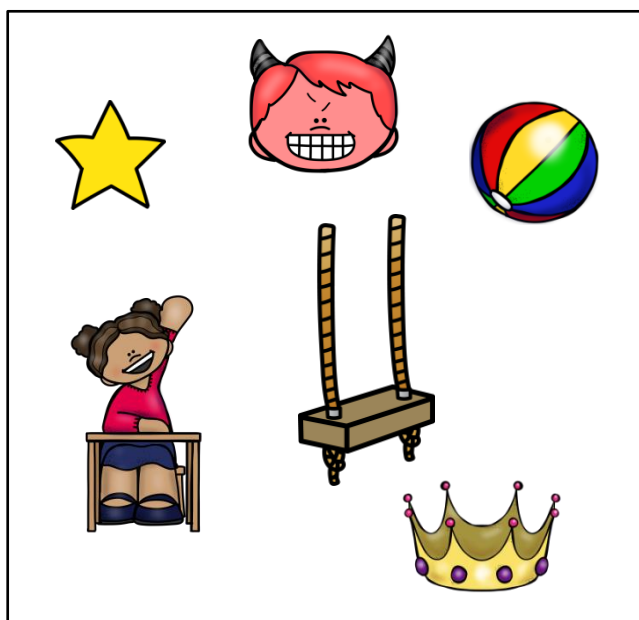

1 Обој

Ee

2 Допиши слово које недостаје

Д		Е
---	--	---

Д	Ђ	
---	---	--

	Ђ	Е
--	---	---

3 Повежи

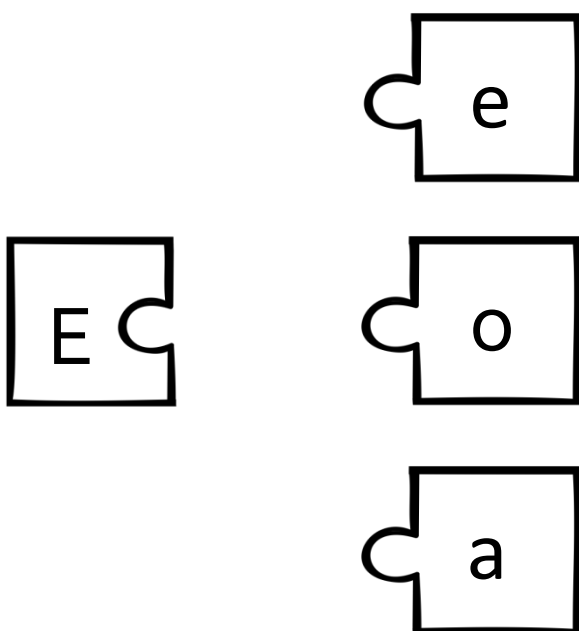

4 Обој слово е

е	е	а	а
а	е	е	а
е	а	е	а

5 Означи бројевима 1,2,3

Ђђ	Ее	Дд

6 Заокружи све што почиње на слово е



1 Обој

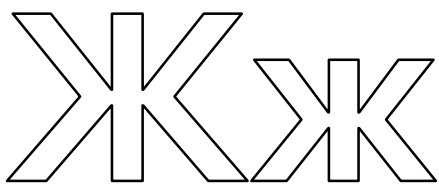

2 Допиши слово које недостаје

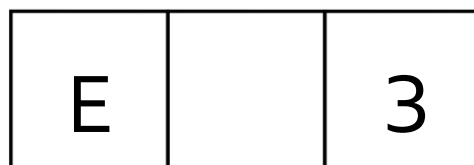
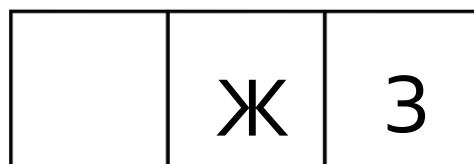
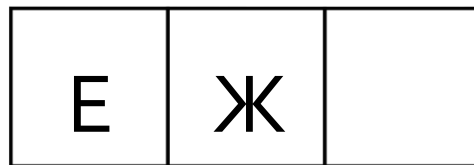

3 Повежи

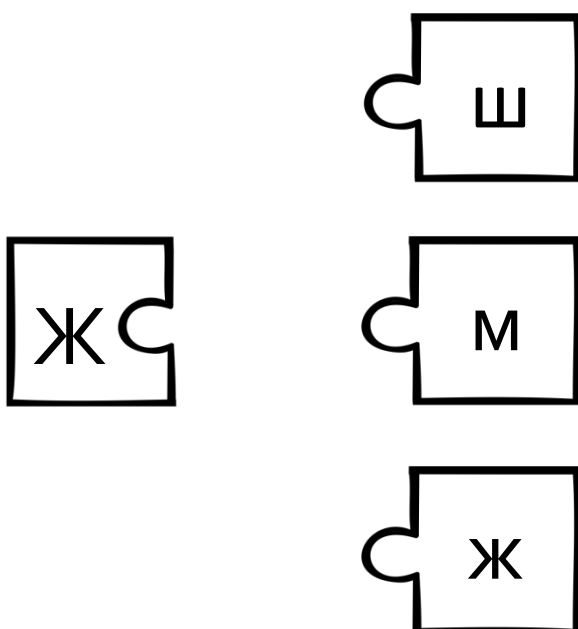

4 Обој слово ж

Ш	Ж	Ж	Ш
Ж	Ш	Ш	Ж
Ж	Ш	Ж	Ш

5 Означи бројевима 1,2,3

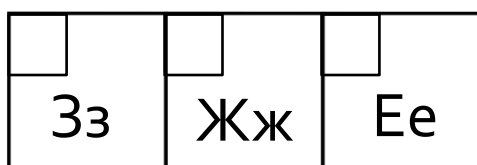

6 Заокружи све што почиње на слово Ж

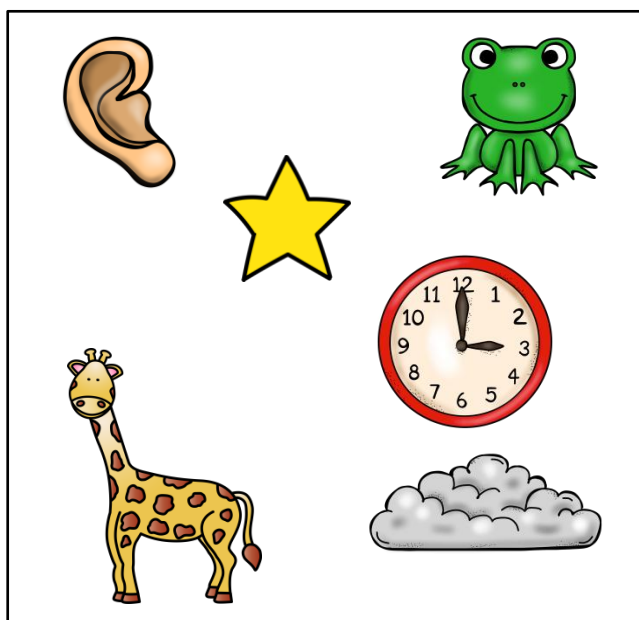

1 Обој

Зз

2 Допиши слово које недостаје

	з	и
--	---	---

3 Повежи

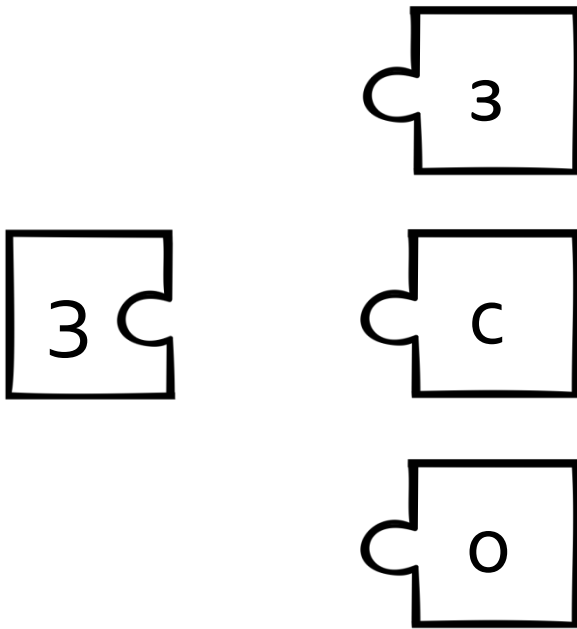

ж		и
---	--	---

ж	з	
---	---	--

4 Обој слово з

з	с	з	с
с	з	з	с
с	з	с	с

6 Заокружи све што почиње на слово з

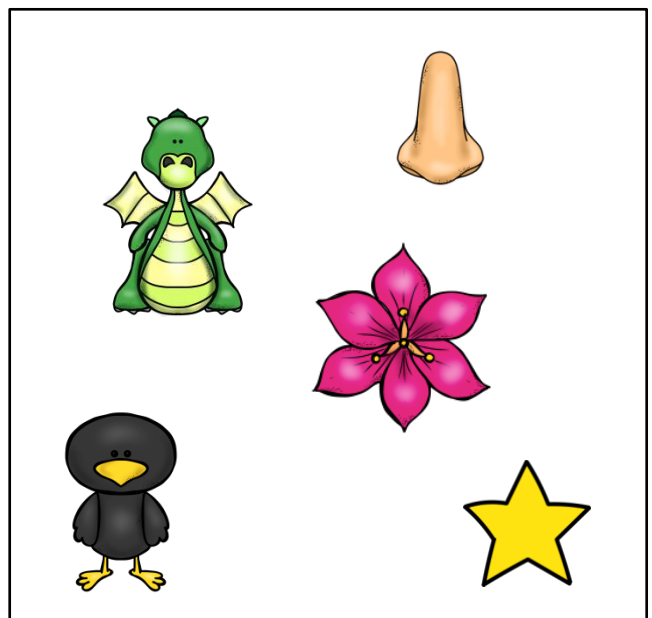

5 Означи бројевима 1,2,3

Ии	Зз	Жж
----	----	----

1 Обој

Ии

2 Допиши слово које недостаје

З		Ј
---	--	---

	И	Ј
--	---	---

З		Ј
---	--	---

3 Повежи

Ис

п

и

н

4 Обој слово и

И	И	Н	Н
Н	И	Н	И
И	Н	И	Н

6 Заокружи све што почиње на слово и

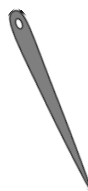
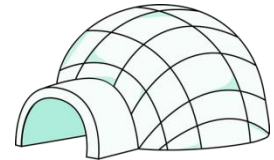

5 Означи бројевима 1,2,3

Ии	Јј	Зз
----	----	----

1 Обој

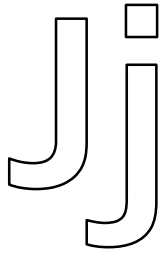

2 Допиши слово које недостаје

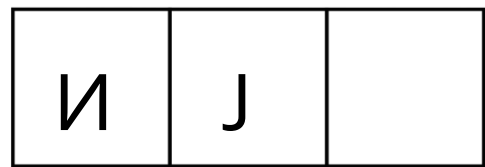
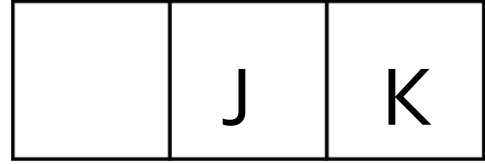

3 Повежи

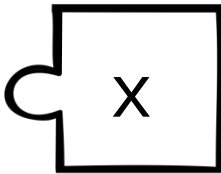
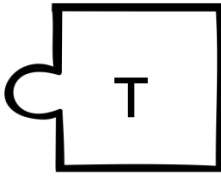
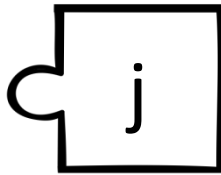
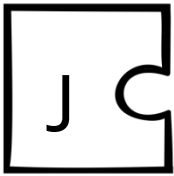

4 Обој слово ј

т	ј	т	т
т	ј	ј	т
ј	т	ј	т

5 Означи бројевима 1,2,3

Јј	Кк	Ии

6 Заокружи све што почиње на слово ј



1 Обој

Кк

2 Допиши слово које недостаје

И		Л
---	--	---

3 Повежи

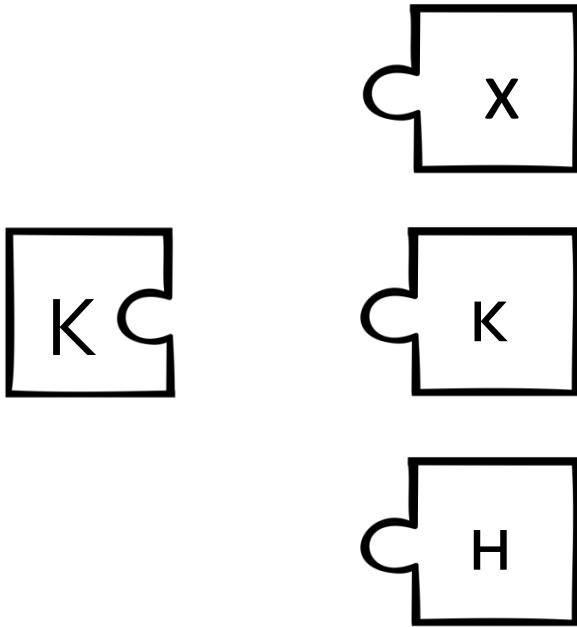

И	К	
---	---	--

	К	Л
--	---	---

4 Обој слово к

К	Х	К	Х
Х	Х	К	К
К	Х	Х	К

6 Заокружи све што почиње на слово к

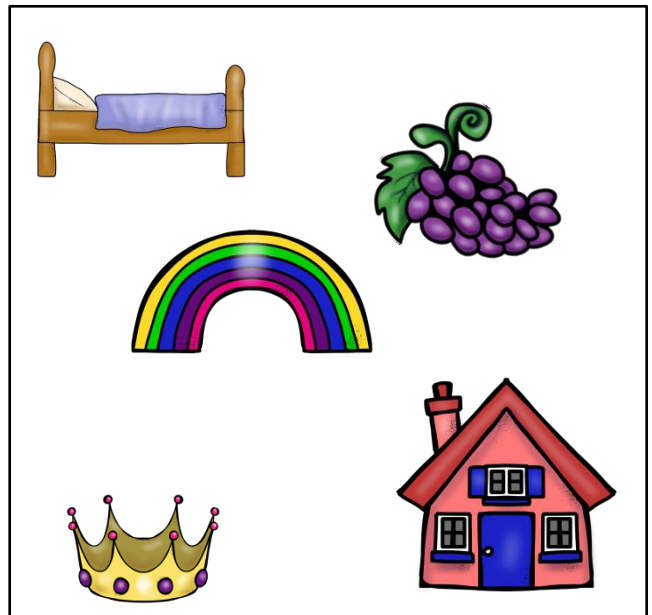

5 Означи бројевима 1,2,3

Кк	Ии	Лл

1 Обој

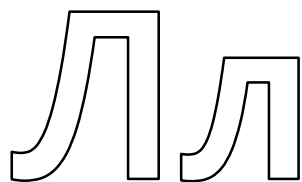

2 Допиши слово које недостаје

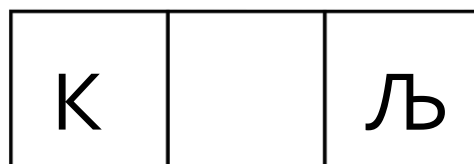
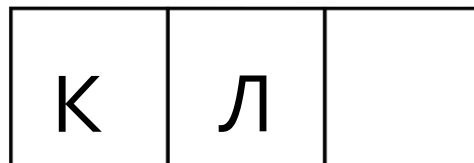

3 Повежи

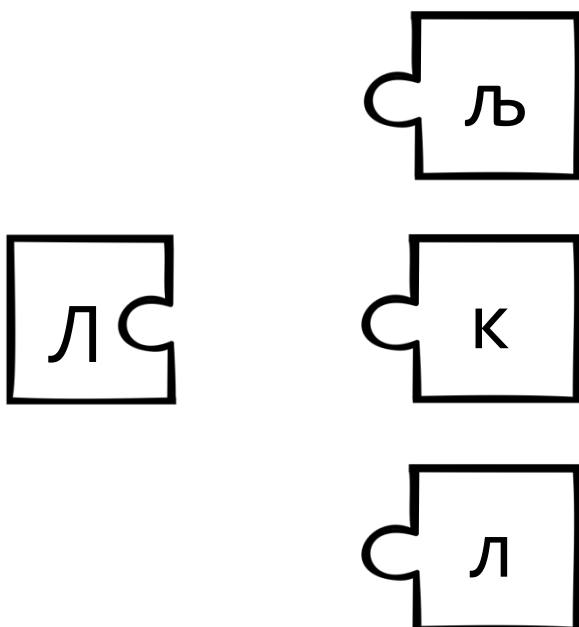

4 Обој слово Л

л	љ	л	љ
л	љ	љ	л
љ	л	л	љ

6 Заокружи све што почиње на слово Л

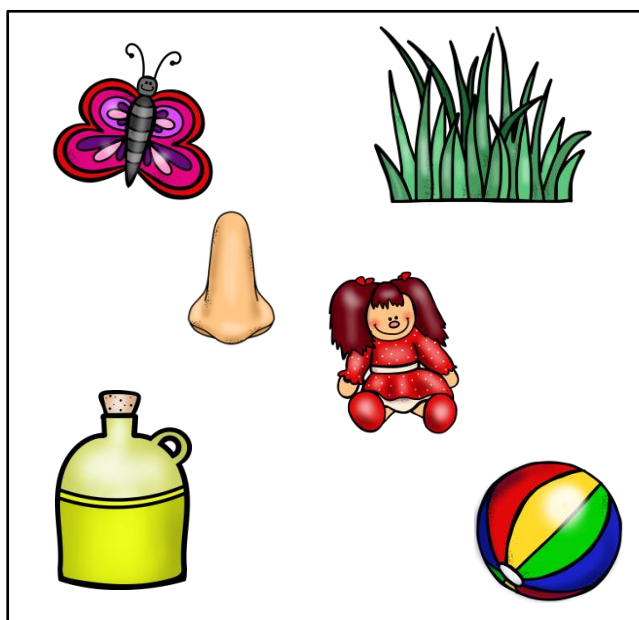

5 Означи бројевима 1,2,3

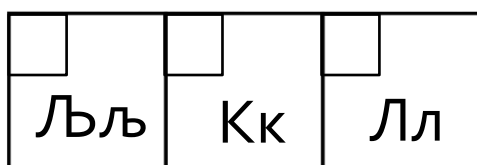

1 Обој

Љ љ

2 Допиши слово које недостаје

	љ	м
--	---	---

3 Повежи

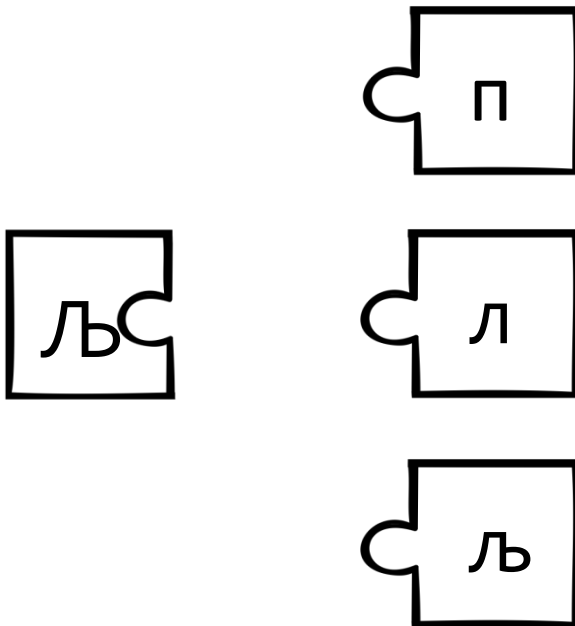

л	љ	
---	---	--

л		м
---	--	---

4 Обој слово љ

љ	љ	л	л
л	л	љ	л
л	л	л	љ

6 Заокружи све што почиње на слово љ



5 Означи бројевима 1,2,3

Мм	Лл	Љљ

1 Обој

ММ

2 Допиши слово које недостаје

Љ	М	
---	---	--

	М	Н
--	---	---

Љ		Н
---	--	---

3 Повежи

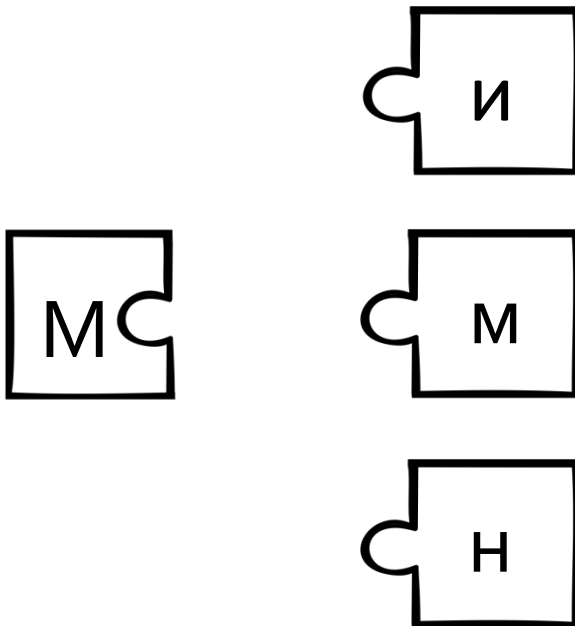

4 Обој слово м

М	Н	Н	М
Н	М	М	Н
М	Н	М	Н

6 Заокружи све што почиње на слово м

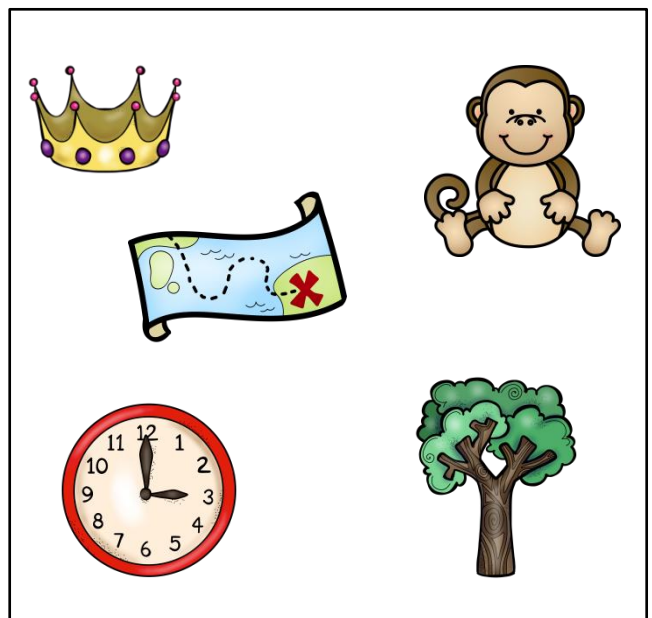

5 Означи бројевима 1,2,3

Нн	Љљ	Мм

1 Обој

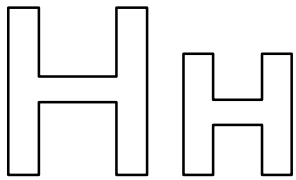

2 Допиши слово које недостаје

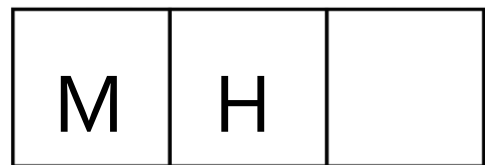
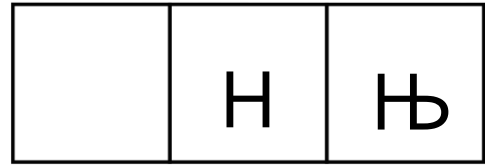

3 Повежи

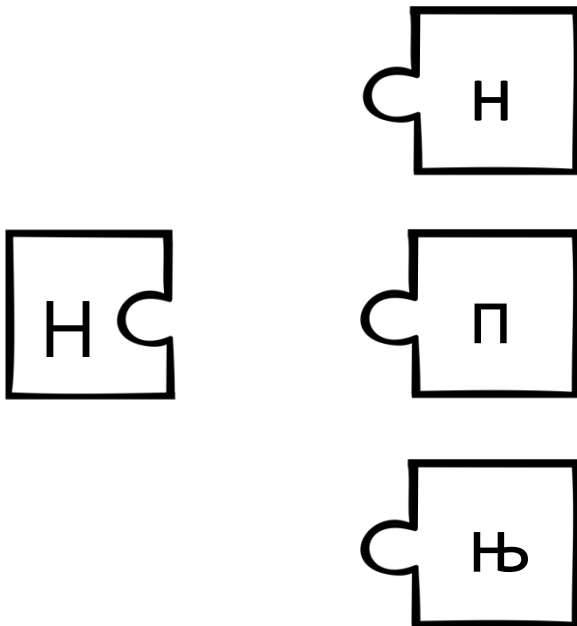

4 Обој слово н

Н	Њ	Н	Њ
Њ	Н	Н	Њ
Н	Њ	Њ	Н

6 Заокружи све што почиње на слово н



5 Означи бројевима 1,2,3

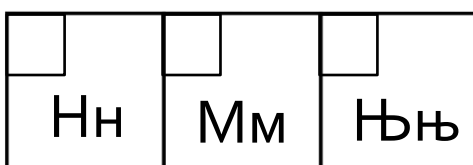

1 Обој

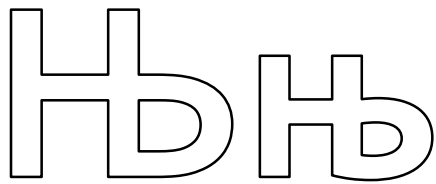

2 Допиши слово које недостаје

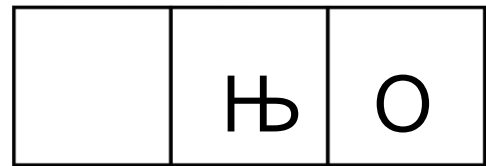
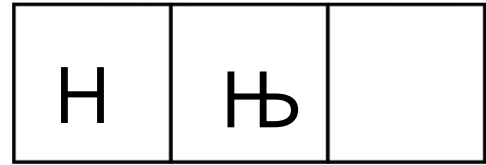

3 Повежи

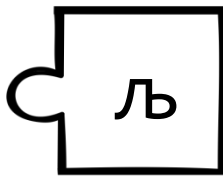
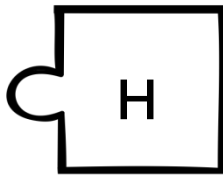
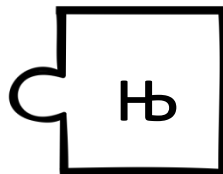

4 Обој слово њ

њ	љ	њ	љ
њ	њ	љ	љ
љ	њ	њ	њ

6 Заокружи све што почиње на слово њ



5 Означи бројевима 1,2,3

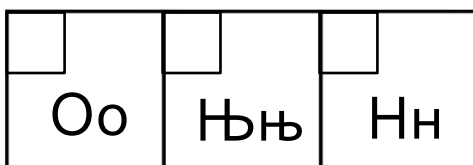

1 Обој

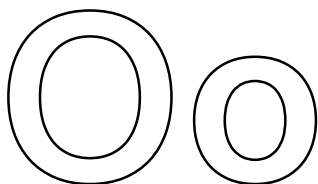

2 Допиши слово које недостаје

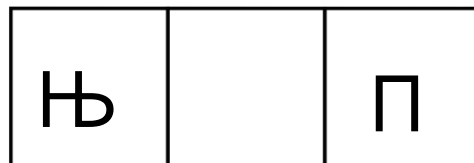

3 Повежи

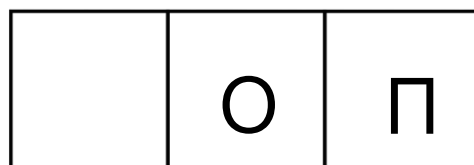
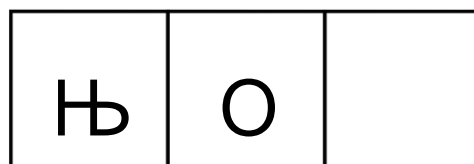
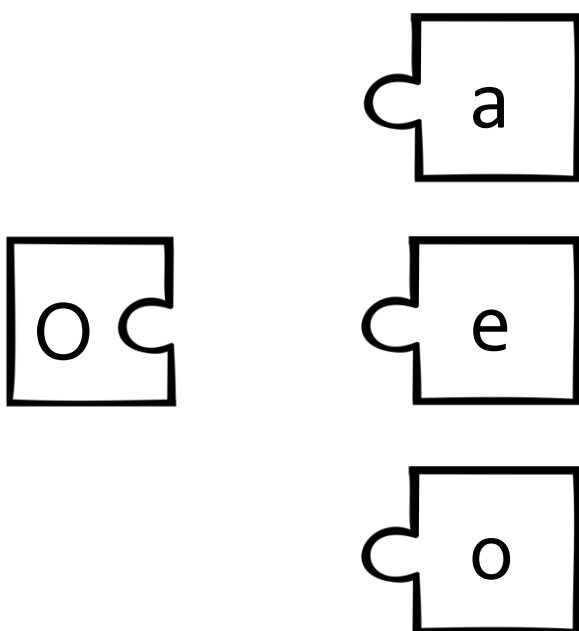

4 Обој слово о

а	о	а	о
а	о	о	а
о	о	о	а

6 Заокружи све што почиње на слово о

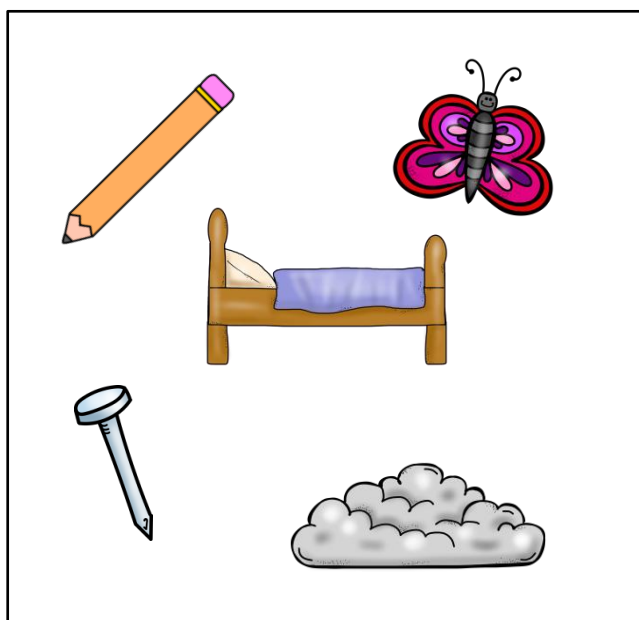

5 Означи бројевима 1,2,3

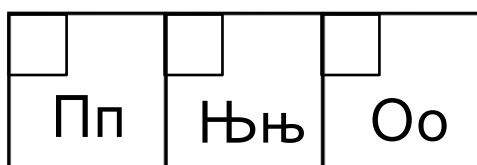

1 Обој

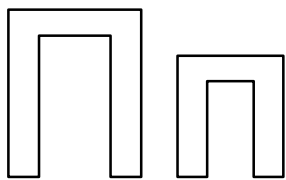

2 Допиши слово које недостаје

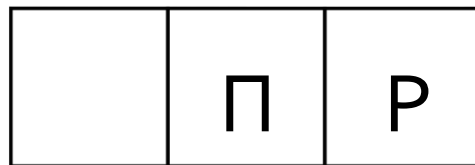

3 Повежи

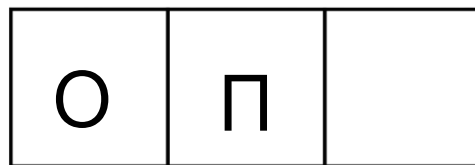
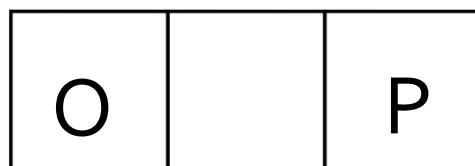
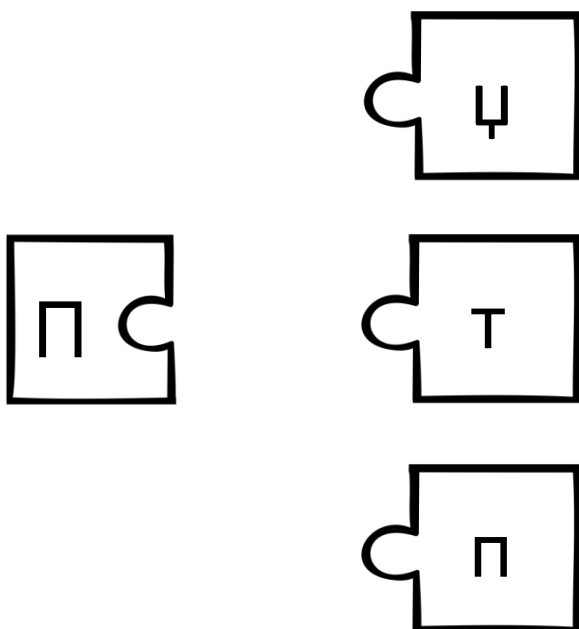

4 Обој слово п

п	п	т	т
т	п	п	т
п	т	п	т

6 Заокружи све што почиње на слово п

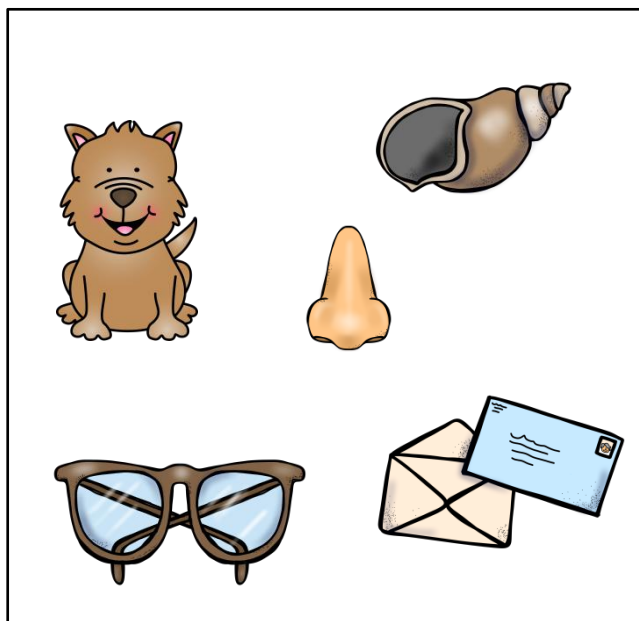

5 Означи бројевима 1,2,3

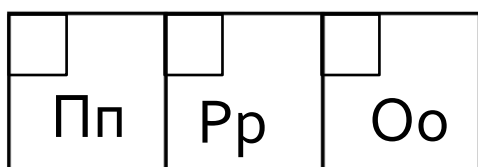

1 Обој

Р р

2 Допиши слово које недостаје

п	р	
---	---	--

	р	с
--	---	---

п		с
---	--	---

3 Повежи

р	с
---	---

б

р

ф

4 Обој слово р

б	р	р	б
р	б	р	б
б	б	р	р

6 Заокружи све што почиње на слово р



5 Означи бројевима 1,2,3

Рр	Пп	Сс

1 Обој

Сс

2 Допиши слово које недостаје

	С	Т
--	---	---

3 Повежи

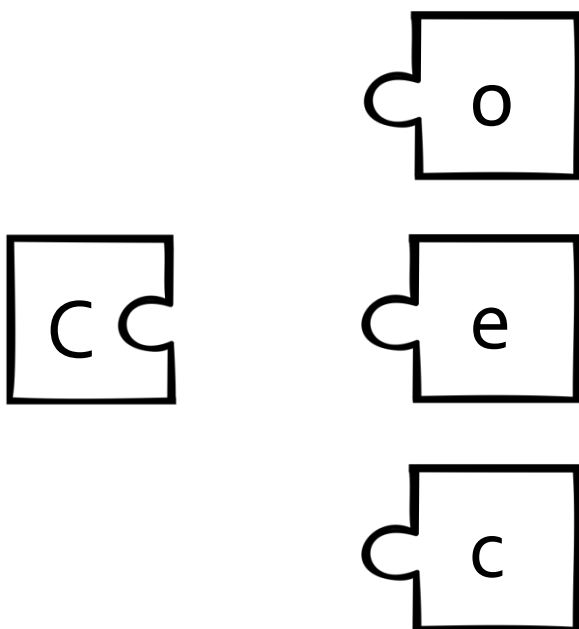

Р		Т
---	--	---

Р	С	
---	---	--

4 Обој слово с

о	с	о	с
с	о	о	с
с	с	о	о

6 Заокружи све што почиње на слово с

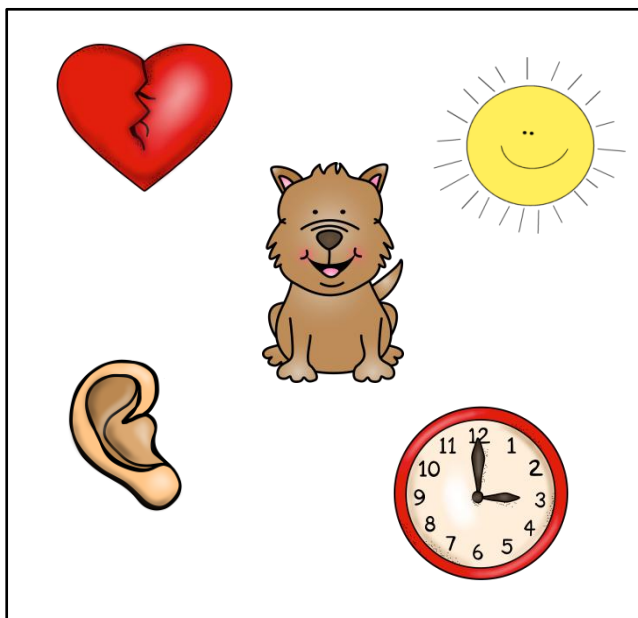

5 Означи бројевима 1,2,3

Сс	Рр	Тт

1 Обој

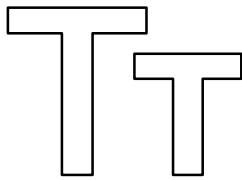

2 Допиши слово које недостаје

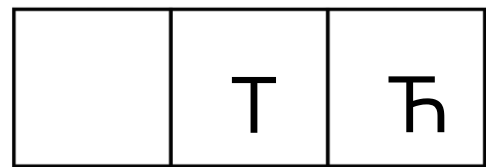
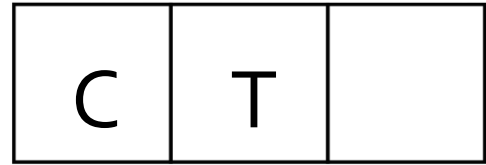

3 Повежи

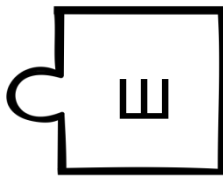
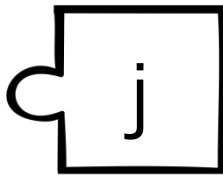
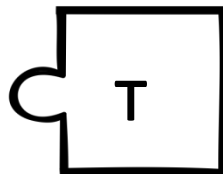
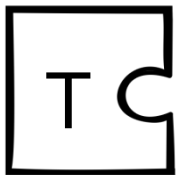

4 Обој слово т

т	т	ш	т
ш	ш	т	т
ш	т	т	ш

5 Означи бројевима 1,2,3

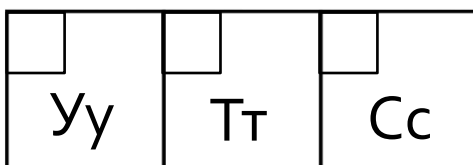

6 Заокружи све што почиње на слово т



1 Обој

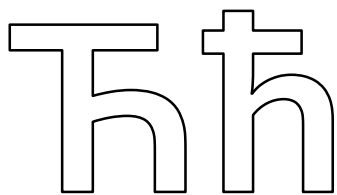

2 Допиши слово које недостаје

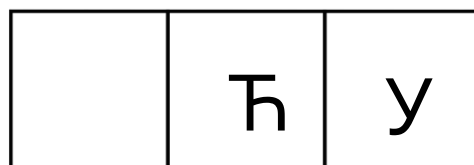
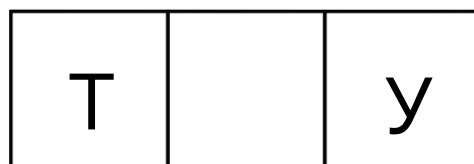
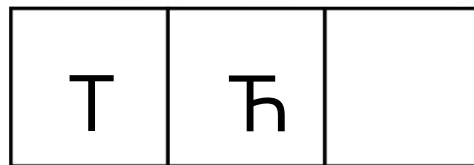

3 Повежи

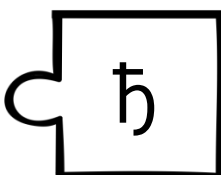
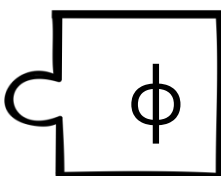
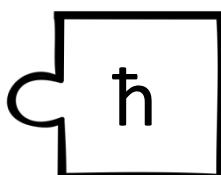
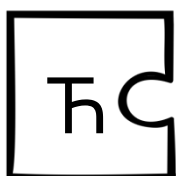

4 Обој слово ћ

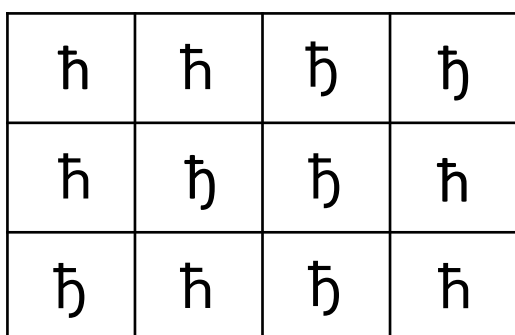

5 Означи бројевима 1,2,3

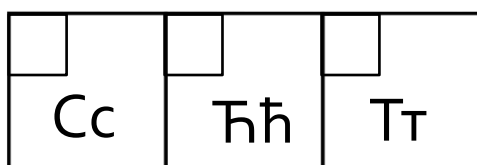

6 Заокружи све што почиње на слово ћ

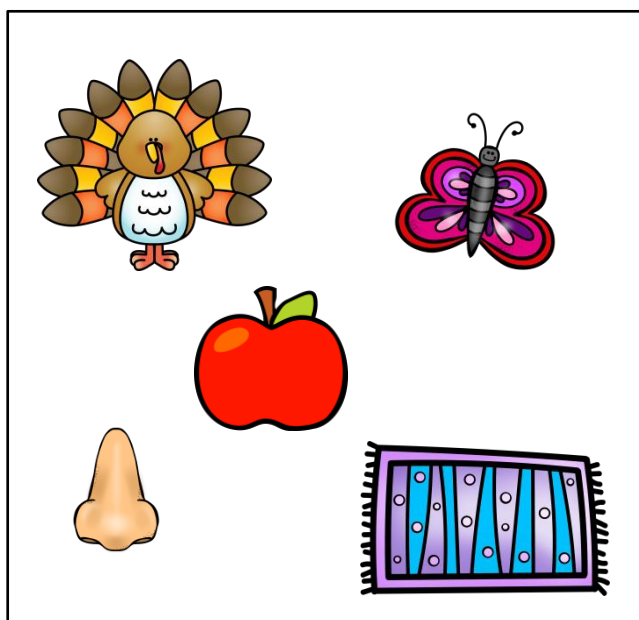

1 Обој

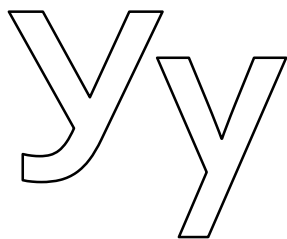

2 Допиши слово које недостаје

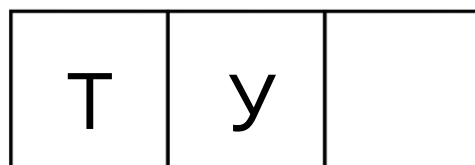
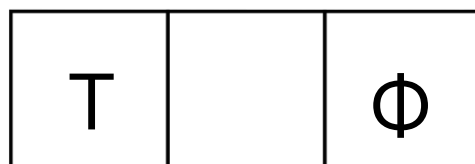
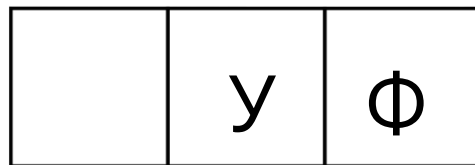

3 Повежи

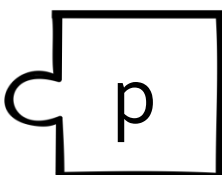
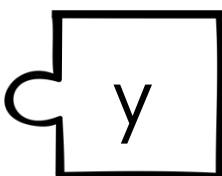
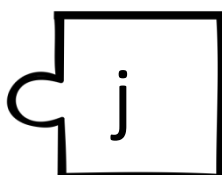
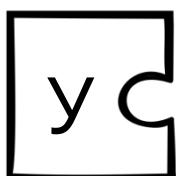

4 Обој слово у

у	у	ј	ј
у	ј	у	ј
ј	у	ј	у

6 Заокружи све што почиње на слово у

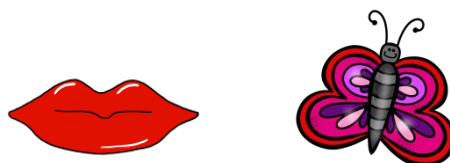

5 Означи бројевима 1,2,3

Тт	Фф	Уу

1 Обој

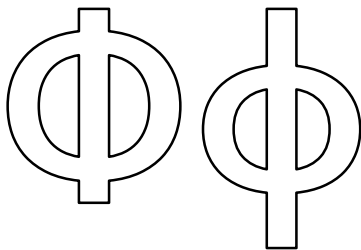

2 Допиши слово које недостаје

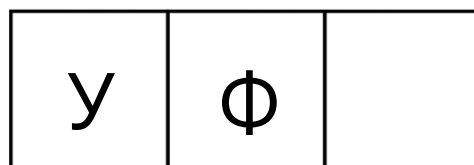
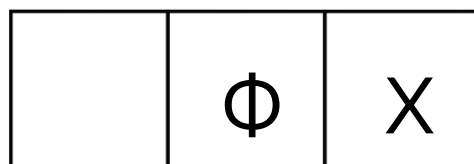
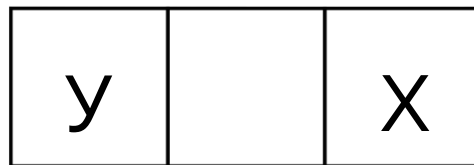

3 Повежи

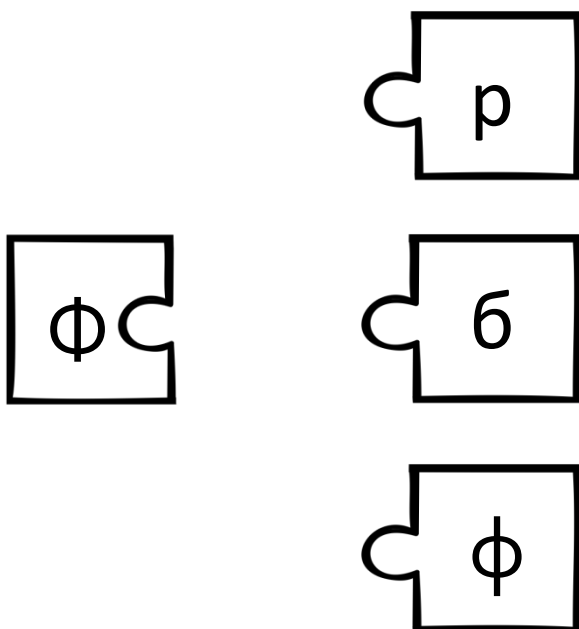

4 Обој слово ф

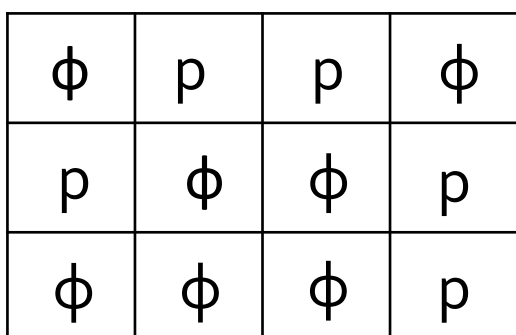

6 Заокружи све што почиње на слово ф



5 Означи бројевима 1,2,3

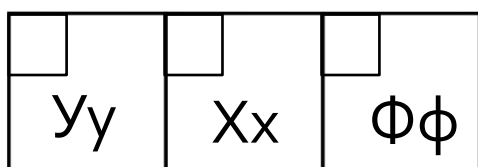

1 Обој

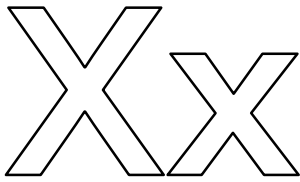

2 Допиши слово које недостаје

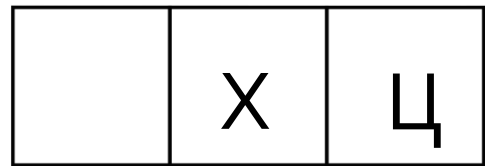
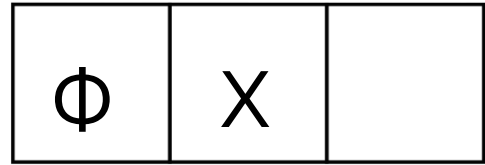

3 Повежи

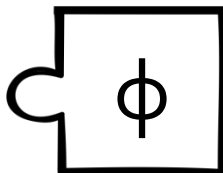
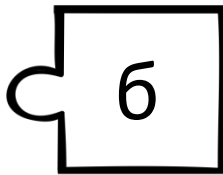
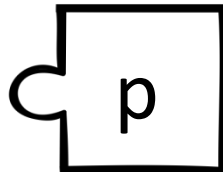
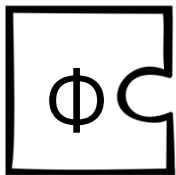

4 Обој слово х

х	ж	х	ж
ж	х	х	ж
ж	х	ж	х

6 Заокружи све што почиње на слово х



5 Означи бројевима 1,2,3

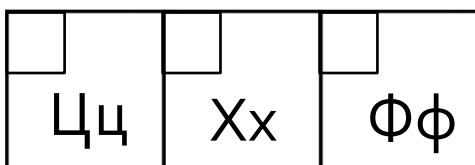

1 Обој

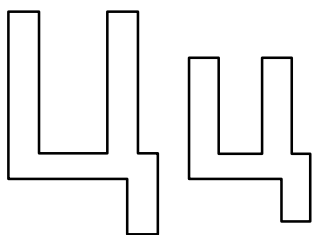

2 Допиши слово које недостаје

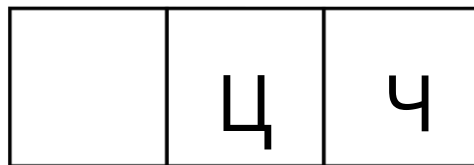

3 Повежи

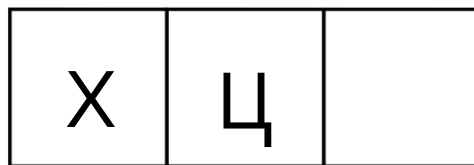
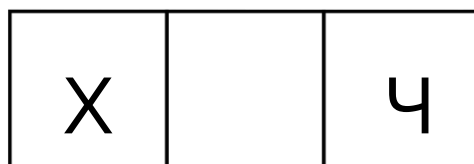
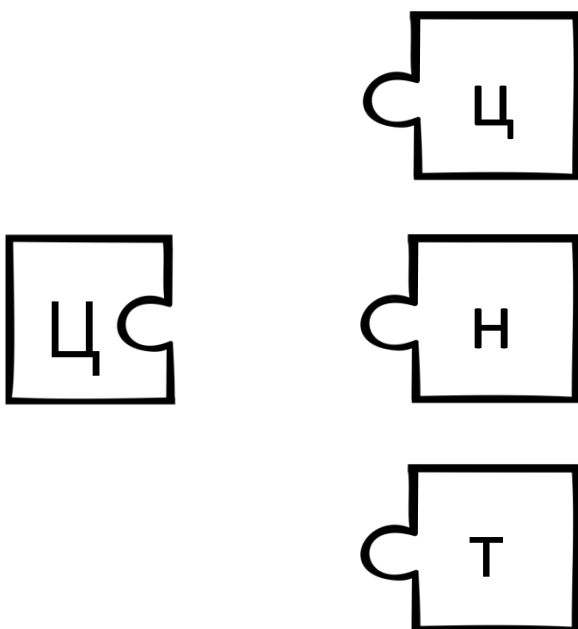

4 Обој слово ц

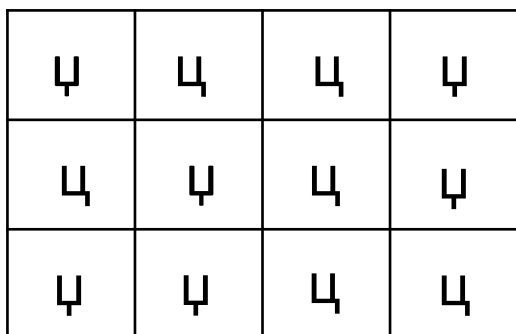

6 Заокружи све што почиње на слово ц



5 Означи бројевима 1,2,3

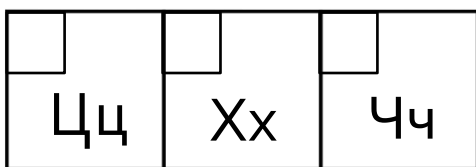

1 Обој

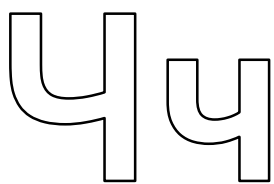

2 Допиши слово које недостаје

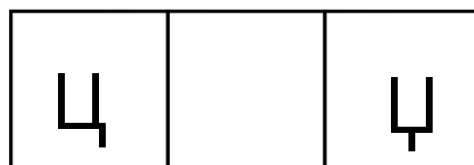
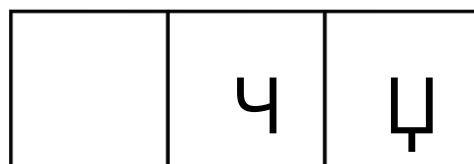
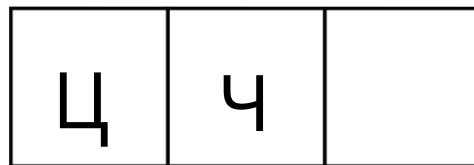

3 Повежи

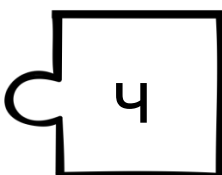
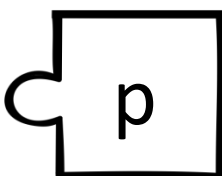
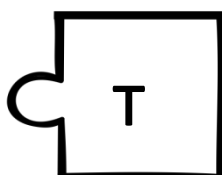
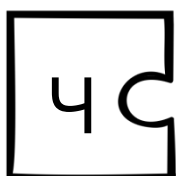

4 Обој слово ч

ч	р	ч	р
р	ч	ч	р
ч	ч	р	р

6 Заокружи све што почиње на слово ч

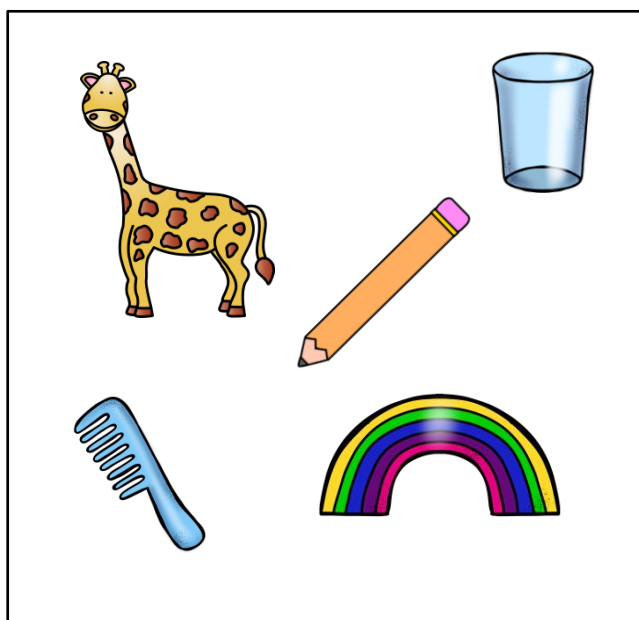

5 Означи бројевима 1,2,3

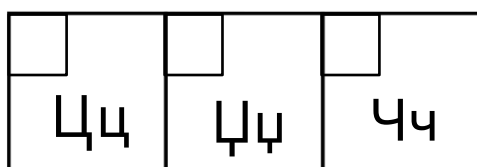

1 Обој

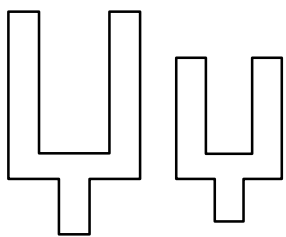

2 Допиши слово које недостаје

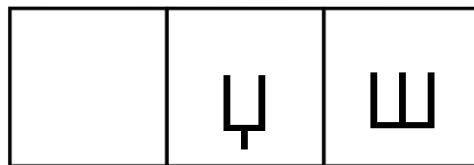

3 Повежи

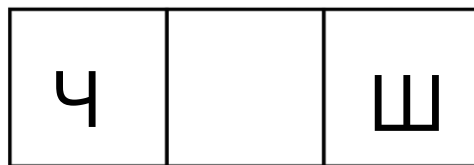
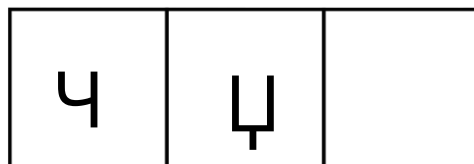
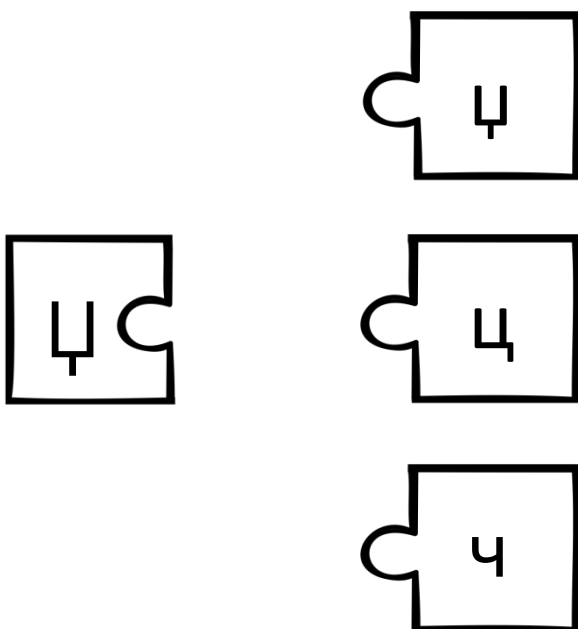

4 Обој слово ц

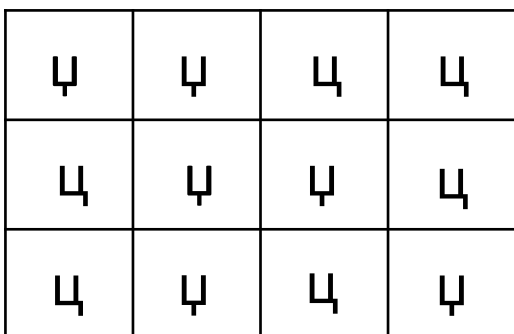

6 Заокружи све што почиње на слово ц

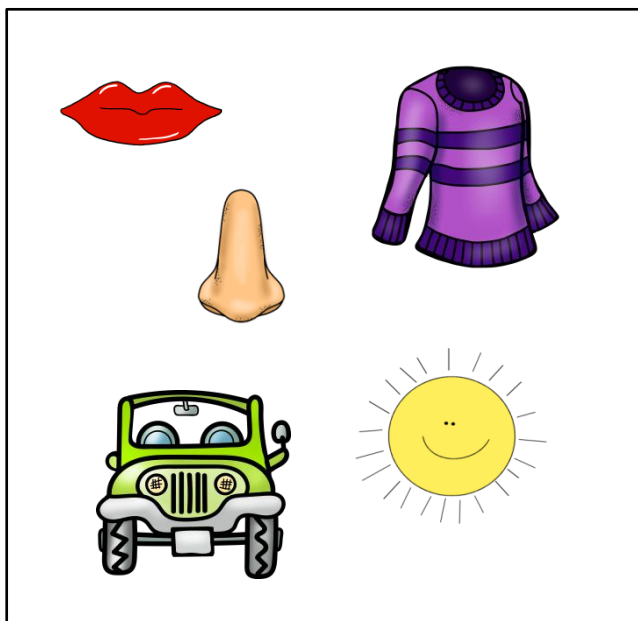

5 Означи бројевима 1,2,3

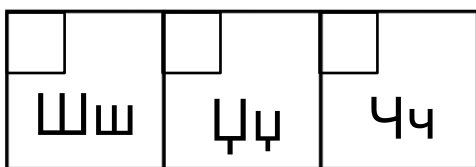

1 Обој

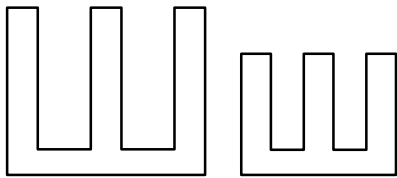

2 Допиши слово које недостаје

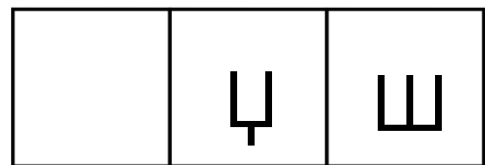
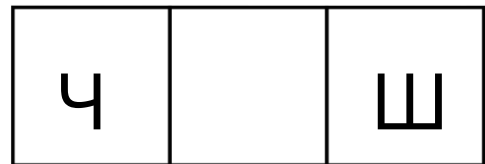
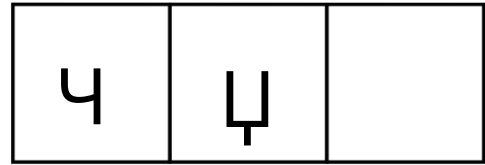

3 Повежи

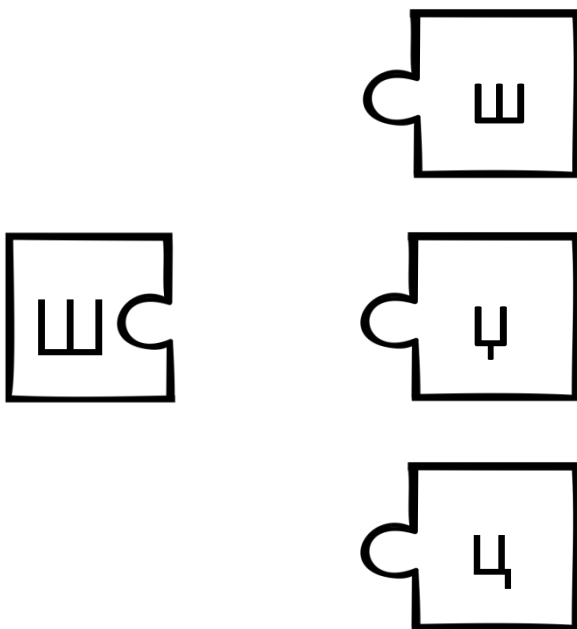

4 Обој слово ш









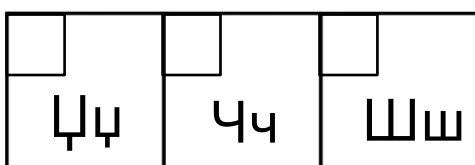

џ	ш	џ	ш
џ	ш	ш	џ
џ	џ	ш	џ

6 Заокружи све што почиње на слово ш



5 Означи бројевима 1,2,3

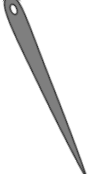

<p>почетак</p>	<p>Аа</p>		<p>Бб</p>
	<p>Вв</p>		<p>Гг</p>
	<p>Дд</p>		<p>Ђђ</p>
	<p>Ее</p>		<p>Жж</p>
	<p>Зз</p>		<p>Ии</p>
	<p>Јј</p>		<p>Кк</p>



Лл



Льль

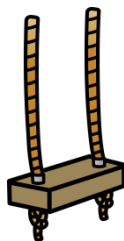

Мм



Нн

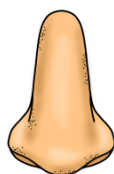

Ньнь



Оо



Пп



Рр

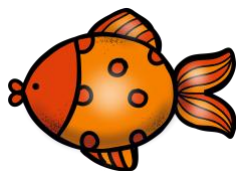

Сс



Тт











Ҫҫ

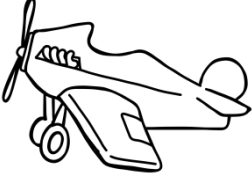
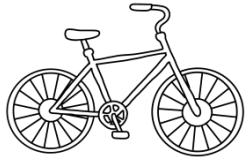

Уу

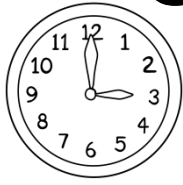
	Фф		Xx
	Цц		Чч
	џџ		Шш
	крај		

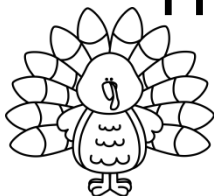
А З Б У К А

<p>Аа</p> 	<p>Бб</p> 	<p>Вв</p> 	<p>Гг</p> 	<p>Дд</p> 
<p>Ђђ</p> 	<p>Ее</p> 	<p>Жж</p> 	<p>Зз</p> 	<p>Ии</p> 
<p>Јј</p> 	<p>Кк</p> 	<p>Лл</p> 	<p>Љљ</p> 	<p>Мм</p> 
<p>Нн</p> 	<p>Њњ</p> 	<p>Оо</p> 	<p>Пп</p> 	<p>Рр</p> 
<p>Сс</p> 	<p>Тт</p> 	<p>Ђђ</p> 	<p>Уу</p> 	<p>Фф</p> 
<p>Хх</p> 	<p>Цц</p> 	<p>Чч</p> 	<p>Џџ</p> 	<p>Шш</p> 

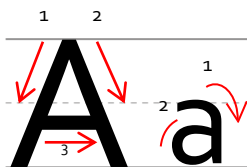
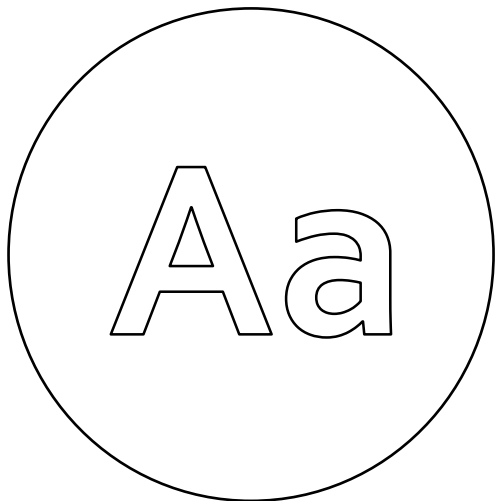

Handwriting practice lines consisting of four sets of horizontal lines. Each set includes a solid top line, a dashed middle line, and a solid bottom line, providing a guide for letter height and placement.

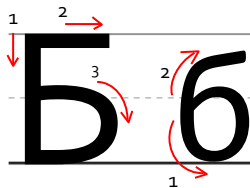
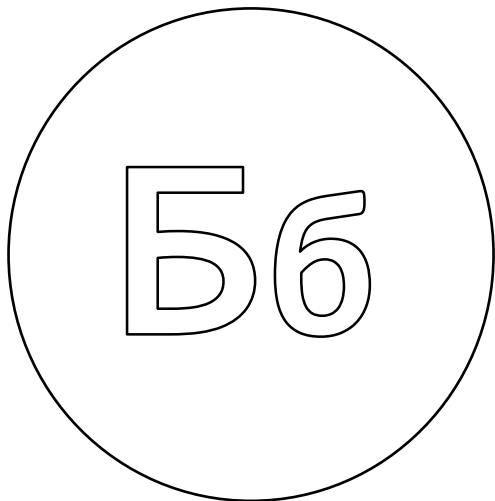

Handwriting practice lines consisting of multiple sets of solid top and bottom lines with a dashed middle line for tracing.

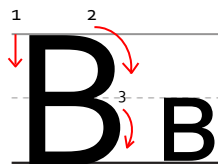
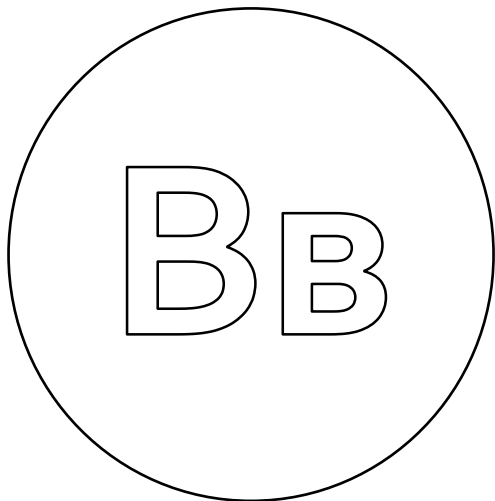

Handwriting practice lines consisting of multiple sets of three horizontal lines (top, middle-dashed, bottom) for practicing the letter 'В'.

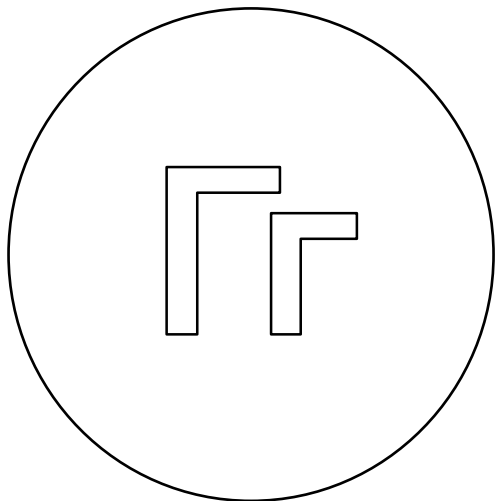

грожђе

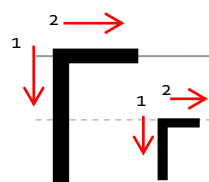

Handwriting practice lines consisting of multiple sets of solid top and bottom lines with a dashed middle line for letter height guidance.

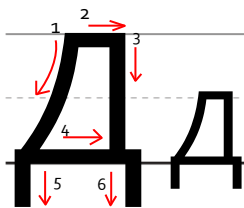
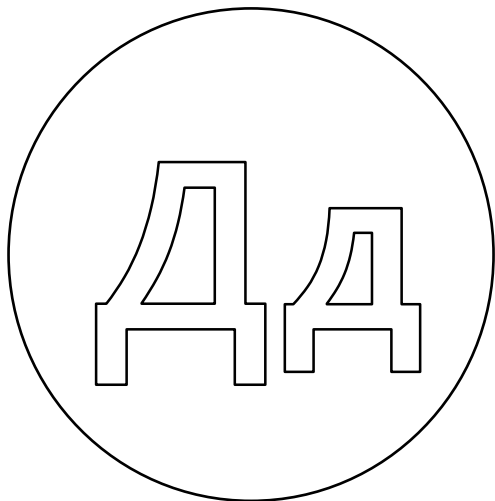

Handwriting practice lines consisting of multiple sets of three horizontal lines (top, middle-dashed, bottom) for practicing the letter 'Д'.

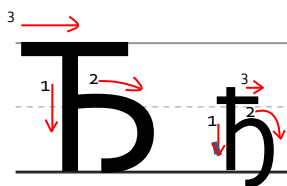

Handwriting practice lines consisting of multiple sets of solid top and bottom lines with a dashed middle line.

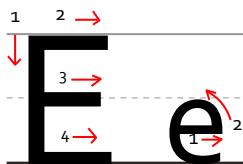
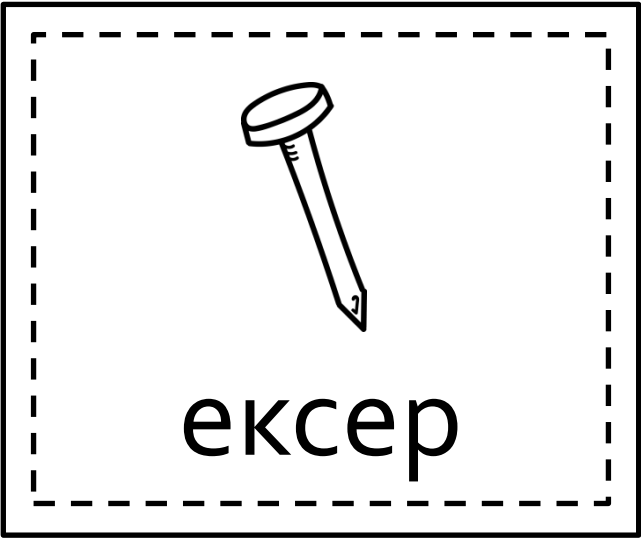
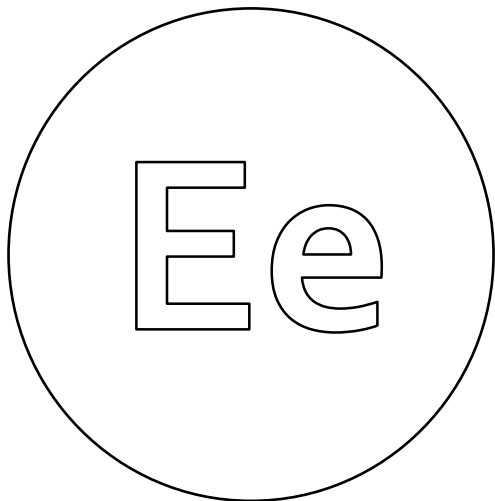

Handwriting practice lines consisting of multiple sets of four horizontal lines (top, middle-dashed, bottom, and baseline).

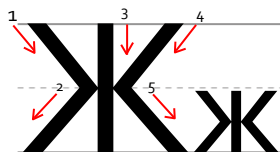
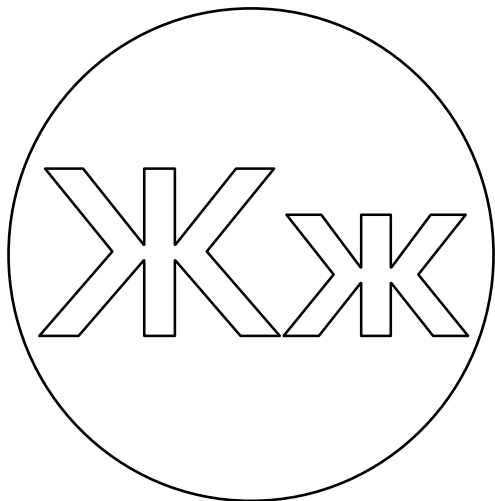

Handwriting practice lines consisting of multiple sets of three horizontal lines (top, middle dashed, bottom) for practicing the letter Ж.

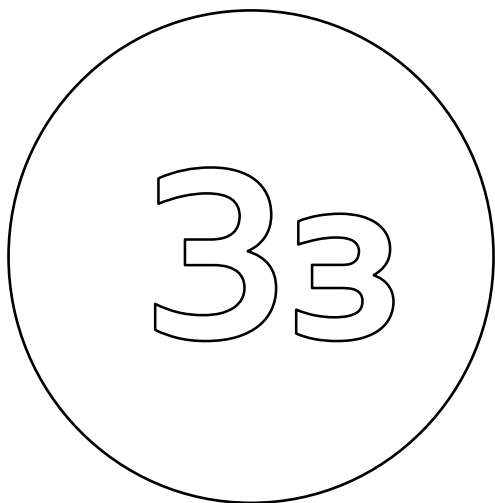

Зз

A tracing guide for the Cyrillic letter 'Зз'. The uppercase 'З' has a red arrow labeled '1' pointing to the top curve and another red arrow labeled '2' pointing to the vertical stem. The lowercase 'з' is positioned to its right.

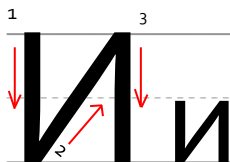
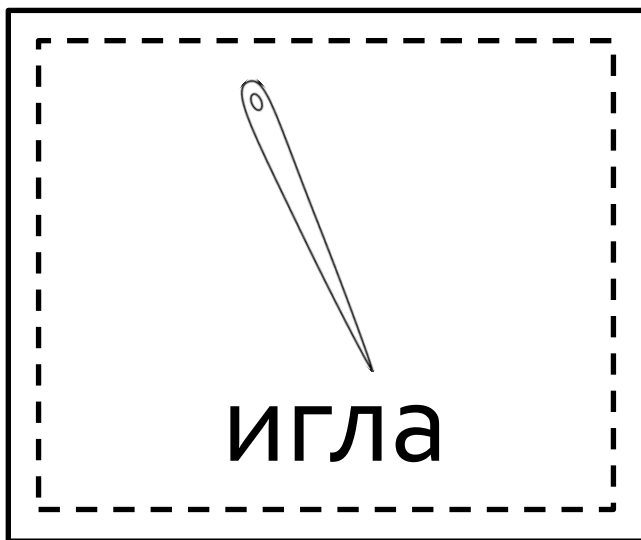
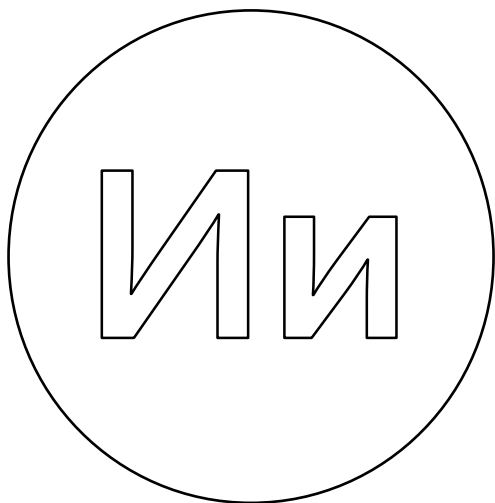

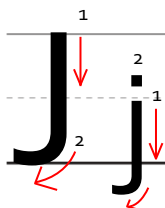
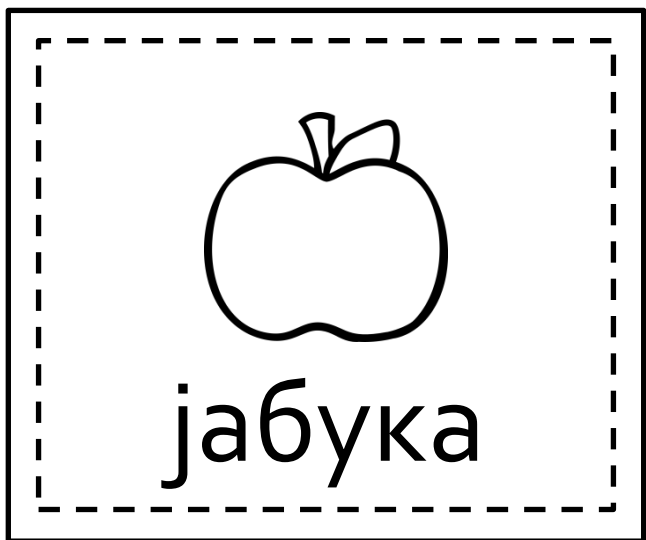
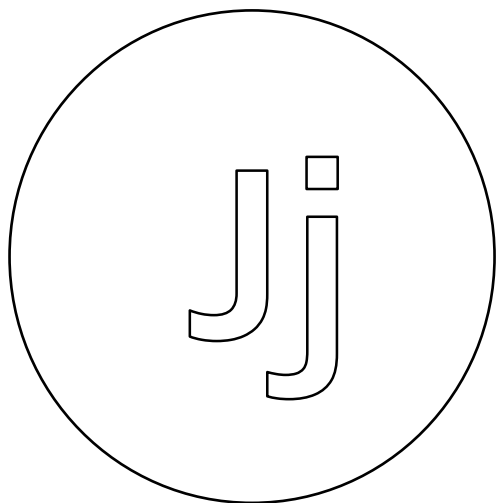

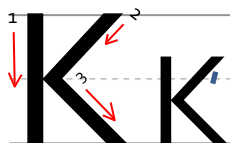
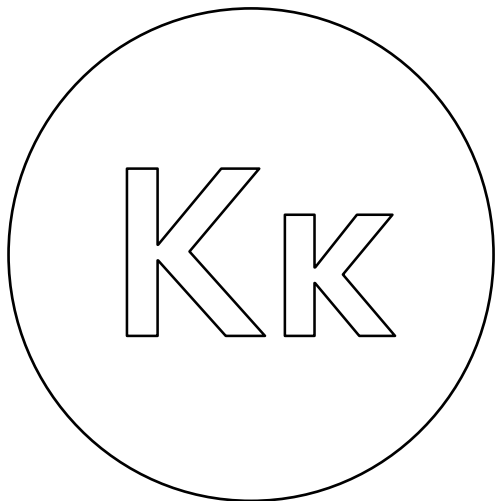

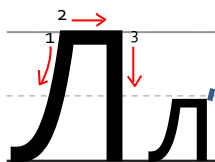
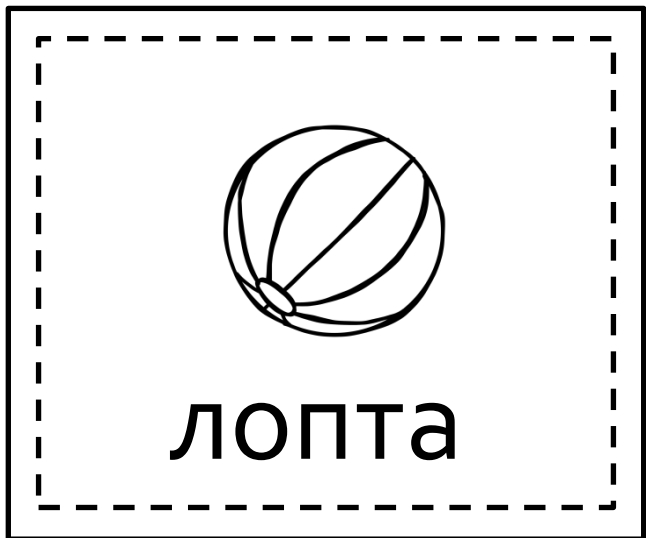
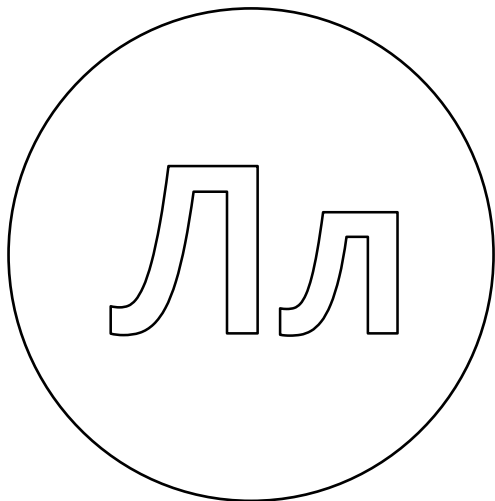

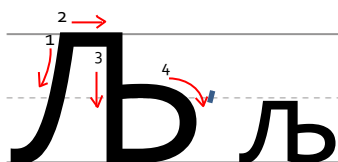
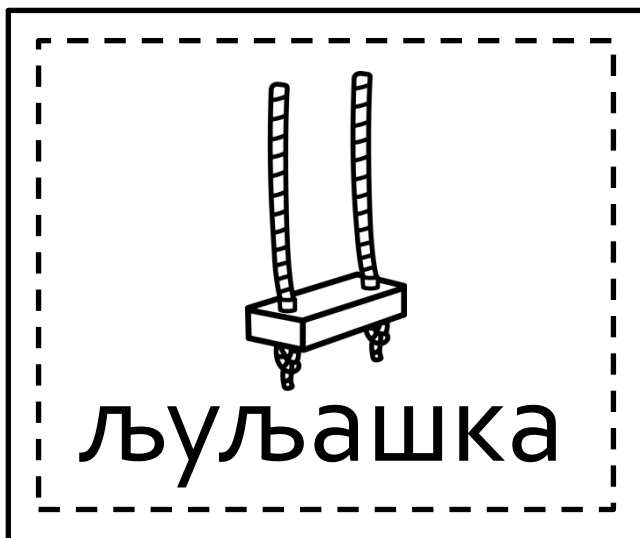
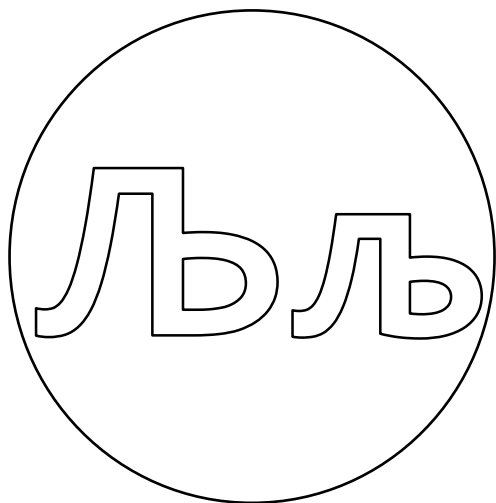

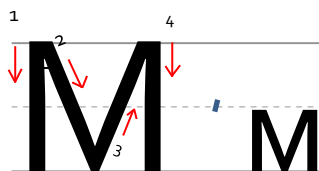
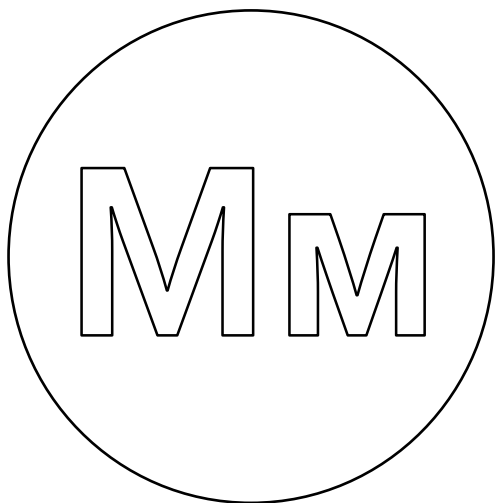

Handwriting practice area consisting of multiple sets of three horizontal lines (top, middle-dashed, bottom) for writing practice.

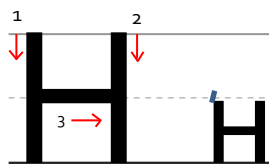
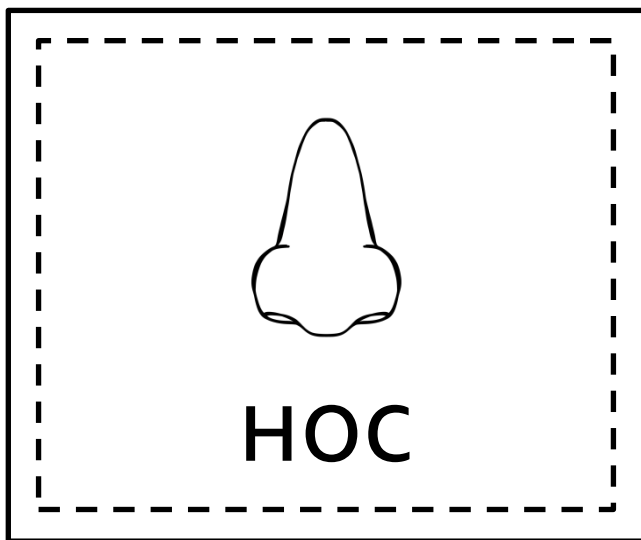
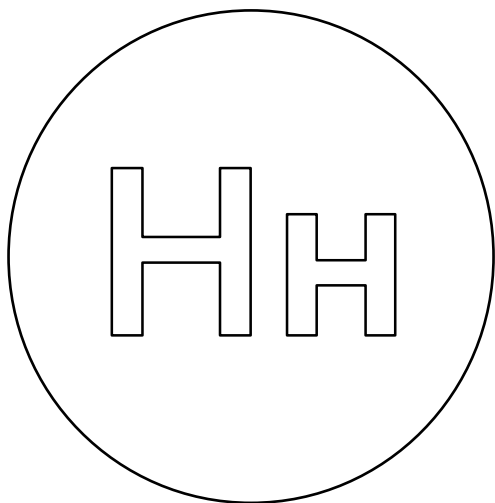

Handwriting practice lines consisting of multiple sets of horizontal lines (top, middle dashed, bottom) for practicing the letter 'Н'.

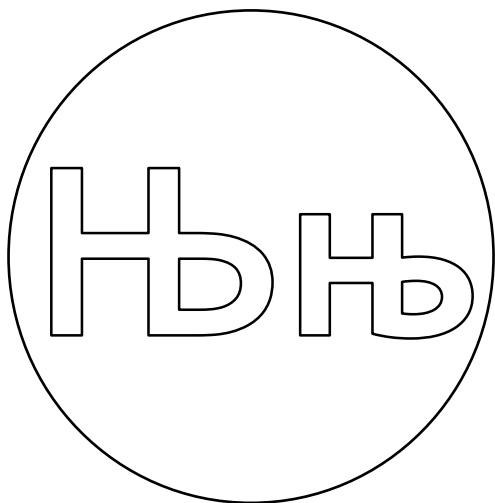

1 2
Н н

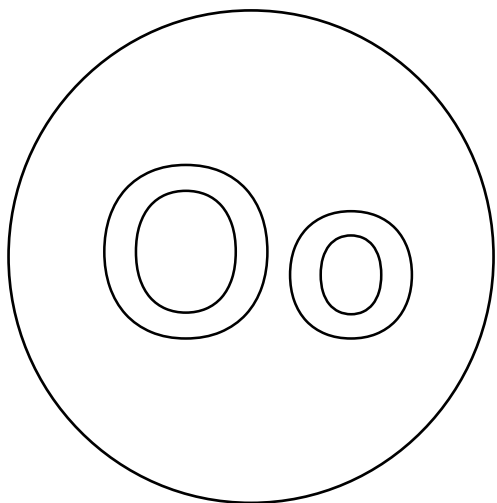

1
O o

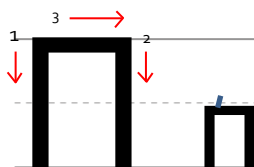
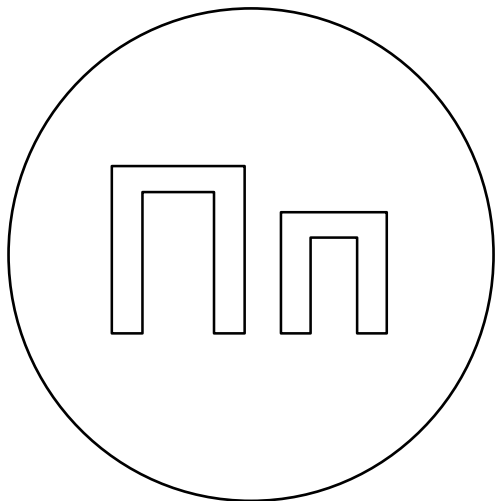

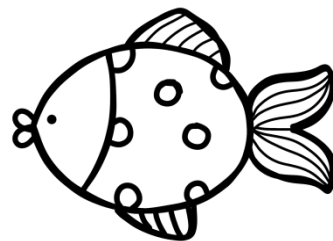
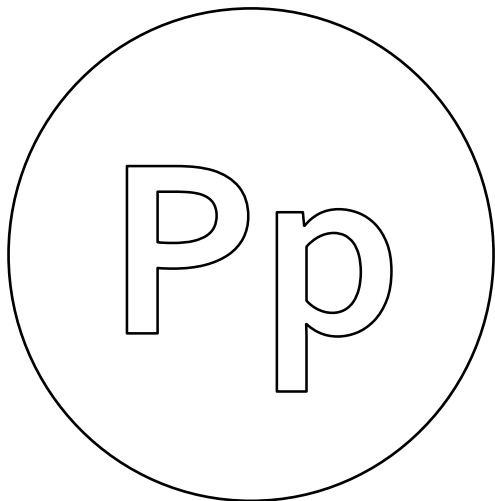

риба

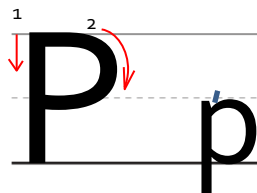

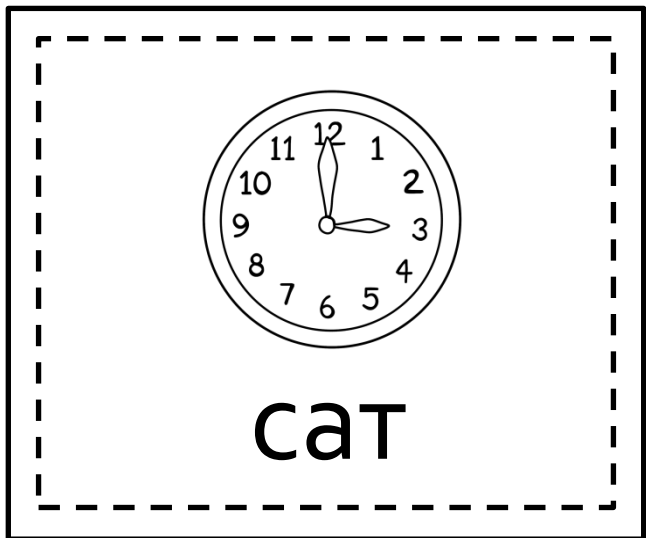
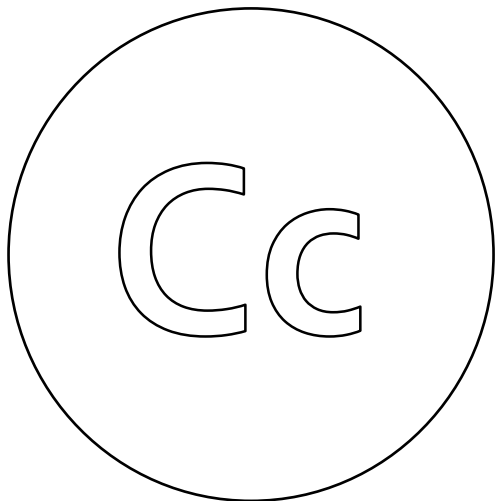

1
C c

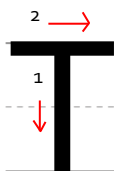
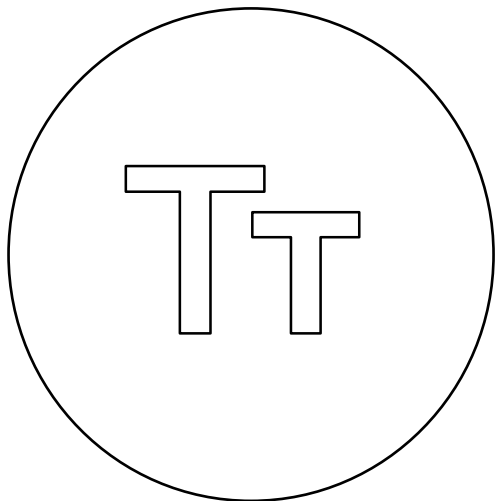

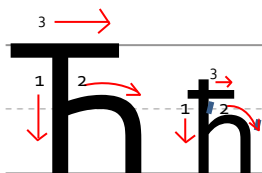
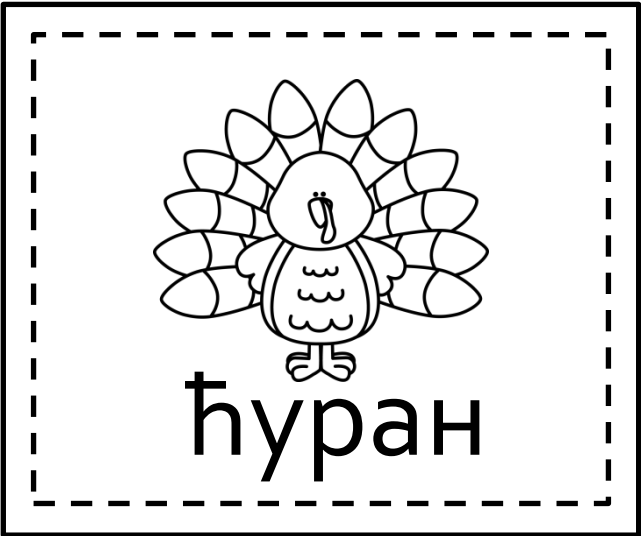
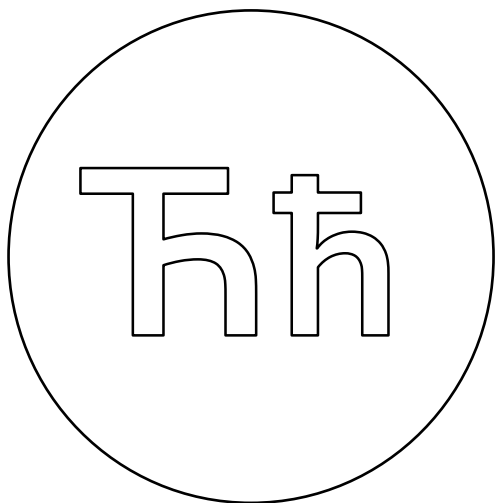

Handwriting practice lines consisting of multiple sets of solid top and bottom lines with a dashed middle line for letter height guidance.

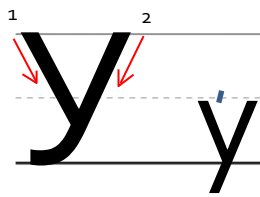
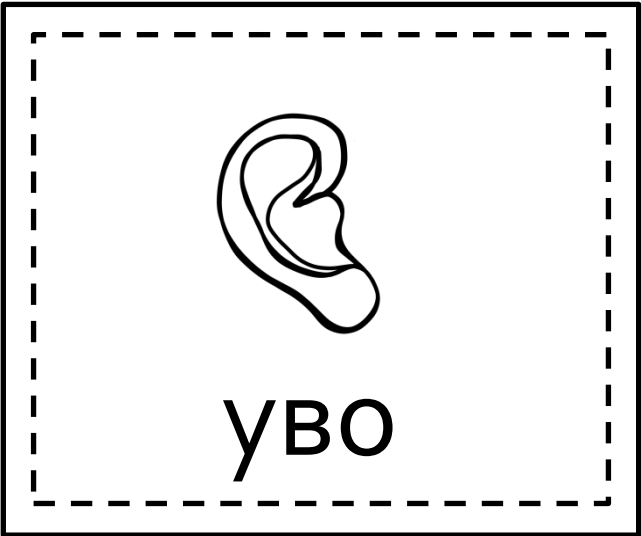
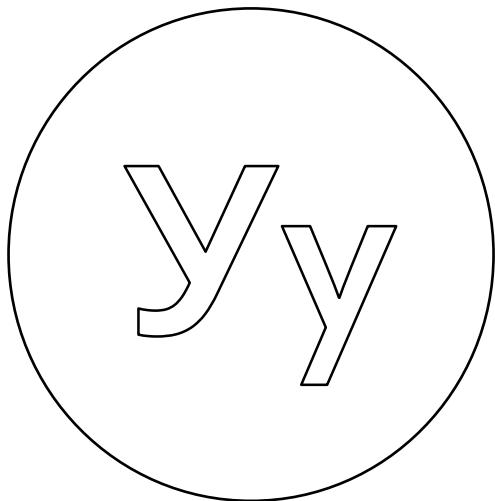

Handwriting practice lines consisting of multiple sets of three horizontal lines (top, middle dashed, bottom) for practicing the letter 'y'.

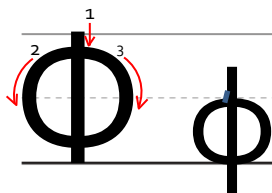
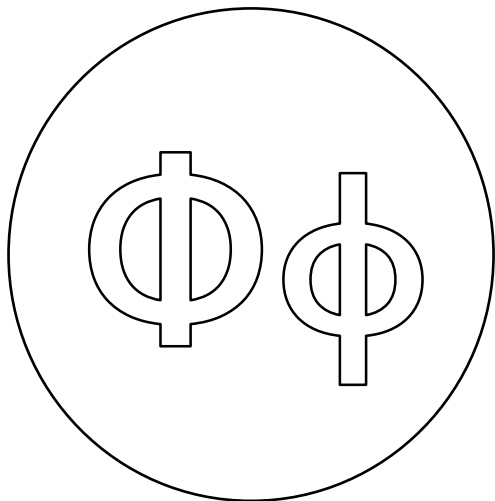

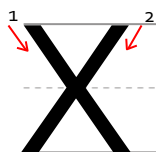
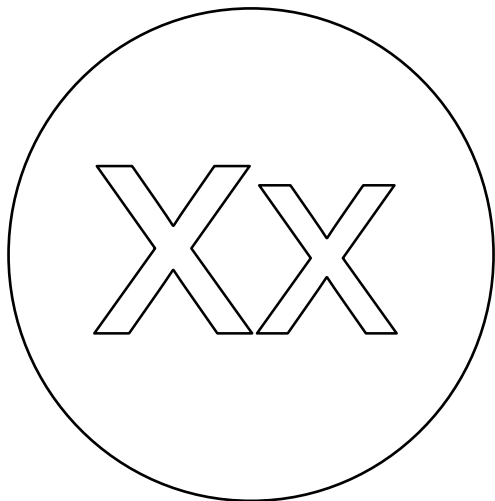

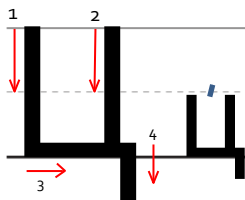
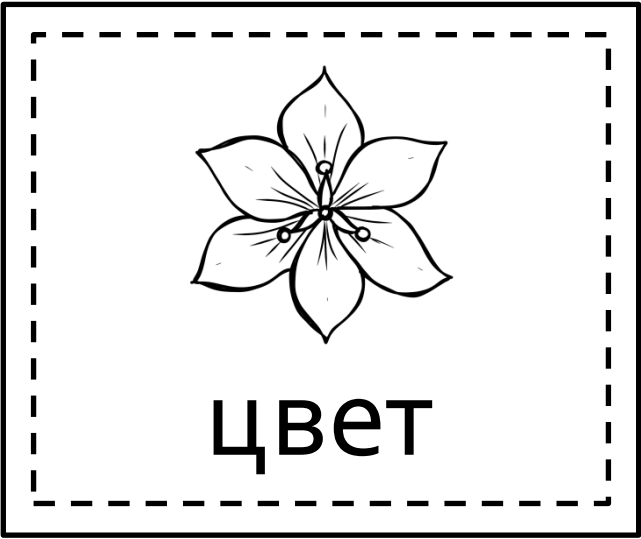
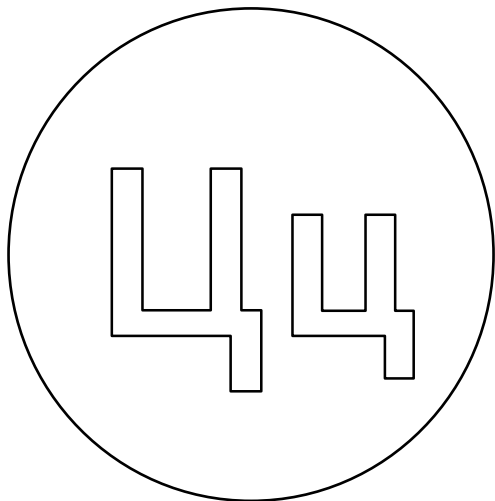

Handwriting practice lines consisting of multiple sets of three horizontal lines (top, middle-dashed, bottom) for practicing the letter 'Ц'.

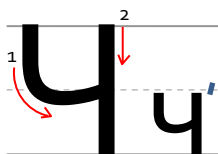
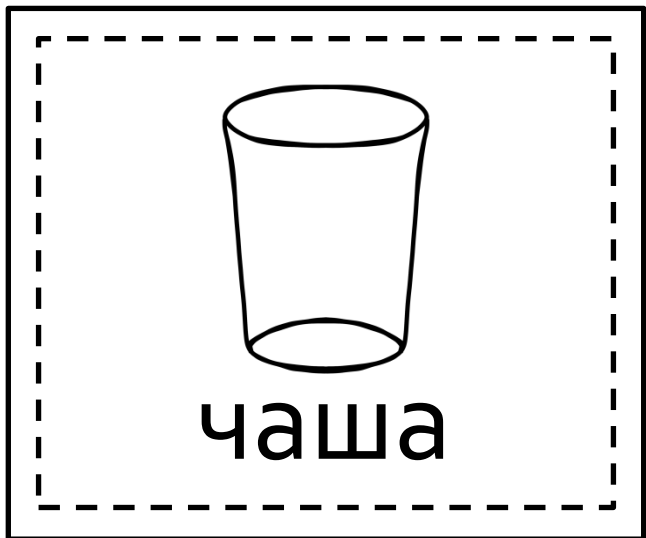
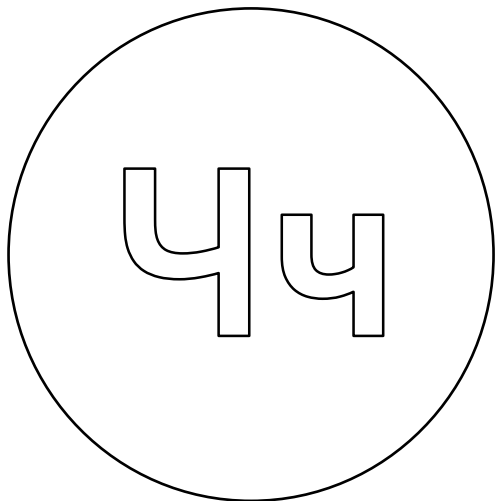

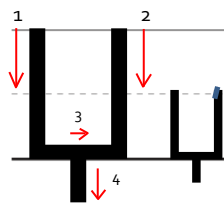
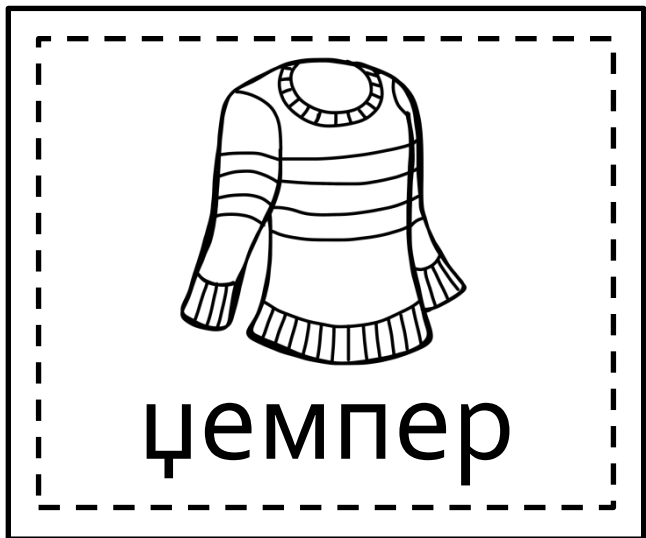
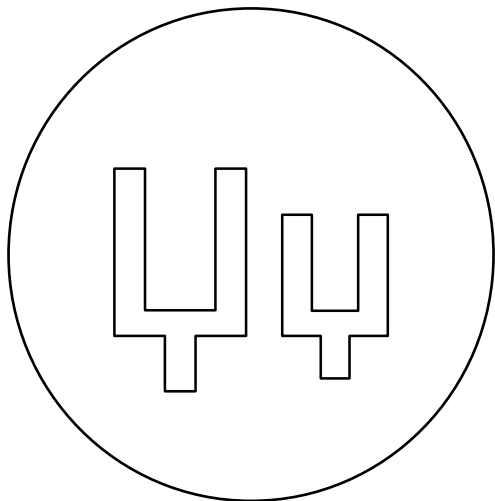

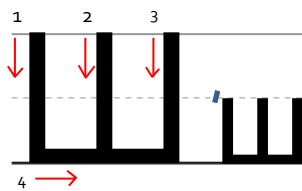
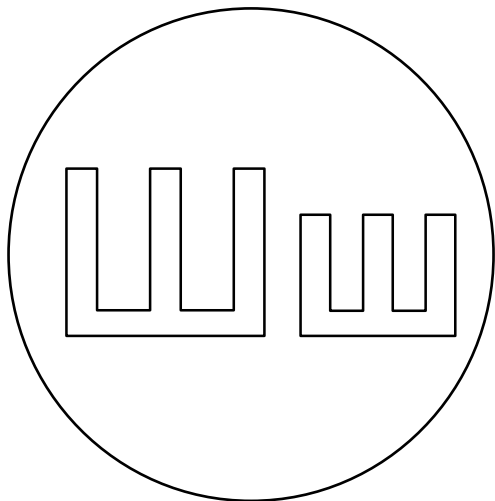

Handwriting practice area consisting of multiple sets of four horizontal lines (top, middle-dashed, bottom, and baseline) for practicing the letter 'ш'.

1 Обој

Aa

2 Допиши слово које недостаје

A		B
---	--	---

	Б	В
--	---	---

A	Б	
---	---	--

3 Повежи

A	C
---	---

e

c

a

4 Обоји слово а

а	е	с	а
е	а	а	с
с	а	е	а

5 Означи бројевима 1,2,3

Vv	Aa	Bb

6 Заокружи све што почиње на слово а

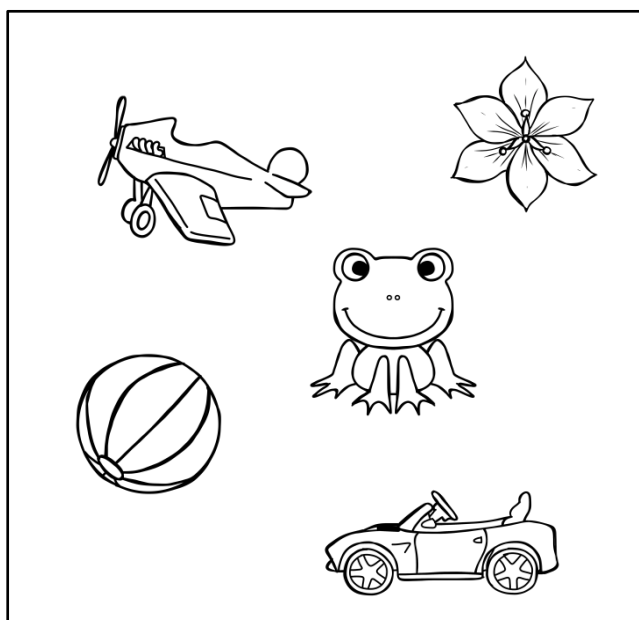

1 Обој

Бб

2 Допиши слово које недостаје

А	Б	
---	---	--

3 Повежи

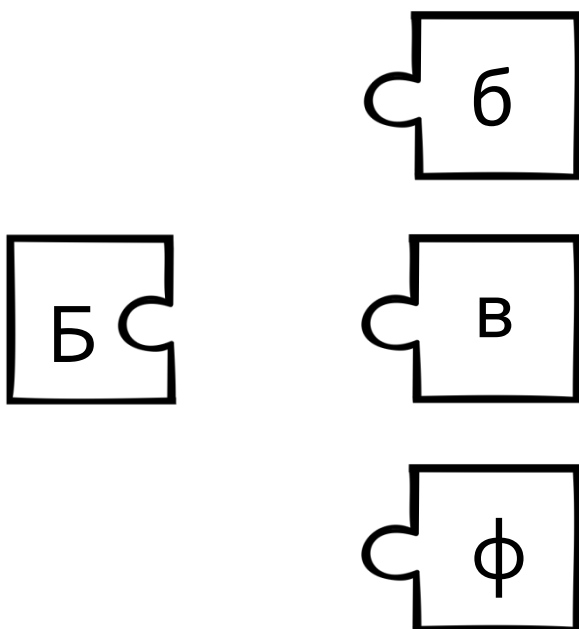

А		В
---	--	---

	Б	В
--	---	---

4 Обој слово б

б	р	б	ф
ф	б	б	р
б	ф	р	б

6 Заокружи све што почиње на слово б

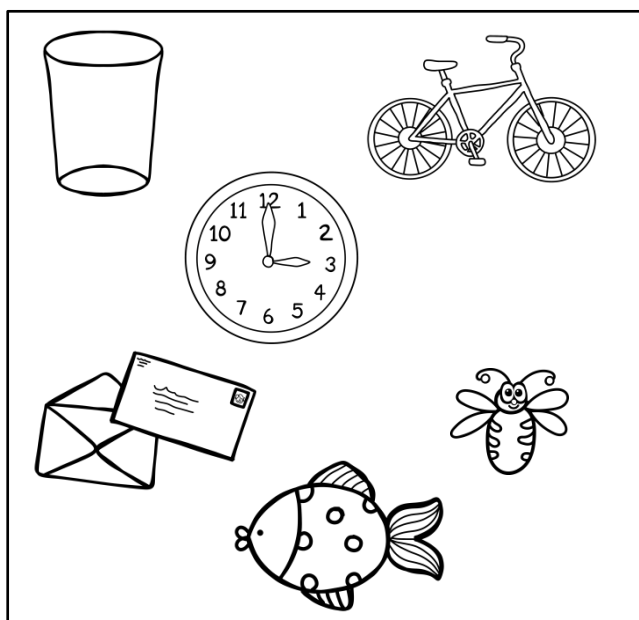

5 Означи бројевима 1,2,3

Бб	Аа	Вв

1 Обој

В В

2 Допиши слово које недостаје

Б		Г
---	--	---

	В	Г
--	---	---

Б	В	
---	---	--

3 Повежи

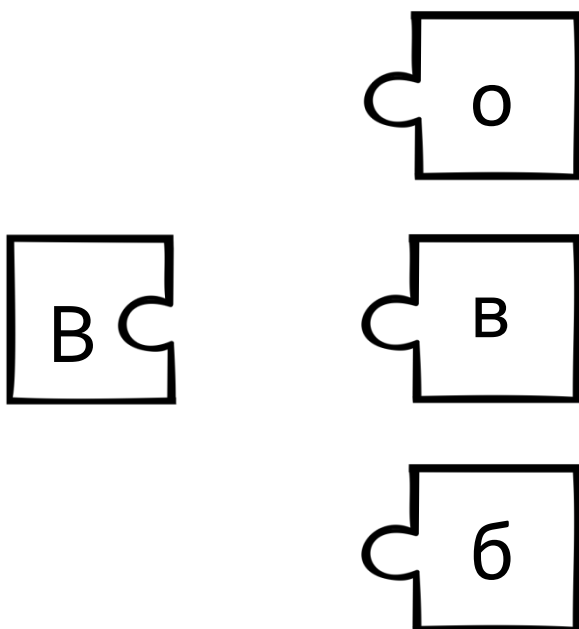

4 Обој слово в

б	в	в	б
ф	в	ф	в
в	б	в	в

6 Заокружи све што почиње на слово в



5 Означи бројевима 1,2,3

Бб	Вв	Аа

1 Обој

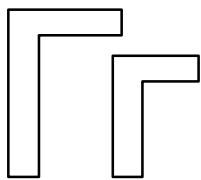

2 Допиши слово које недостаје

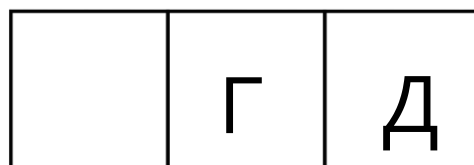
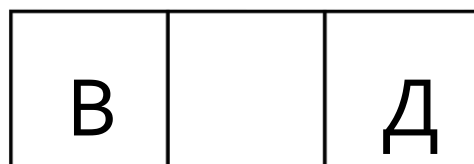
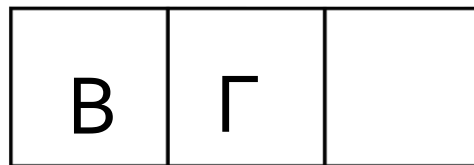

3 Повежи

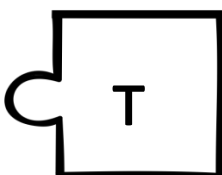
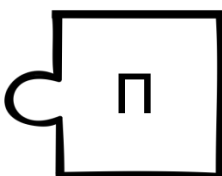
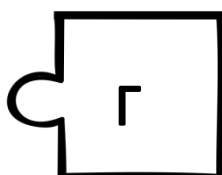
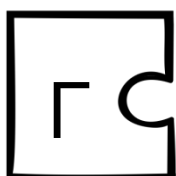

4 Обој слово г

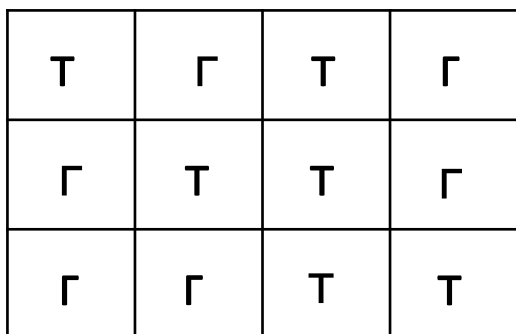

5 Означи бројевима 1,2,3

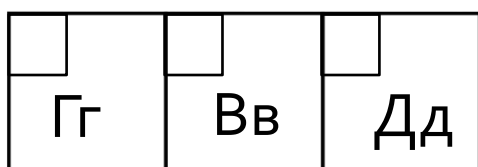

6 Заокружи све што почиње на слово Г

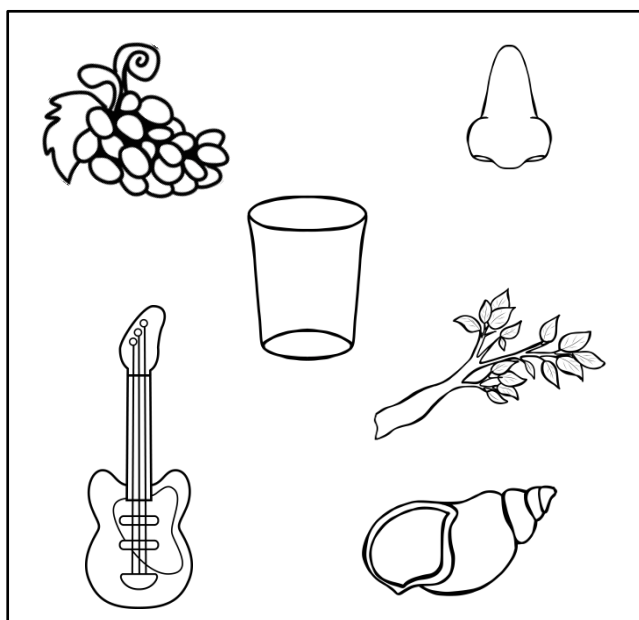

1 Обој

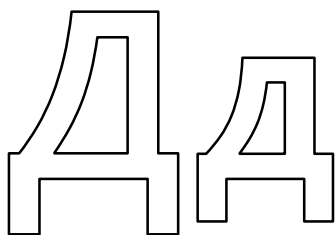

2 Допиши слово које недостаје

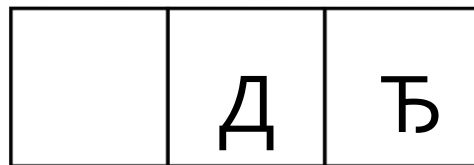

3 Повежи

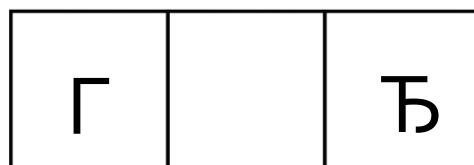
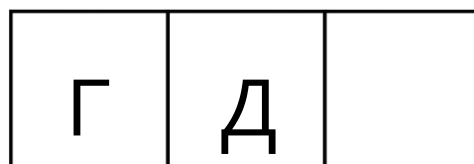
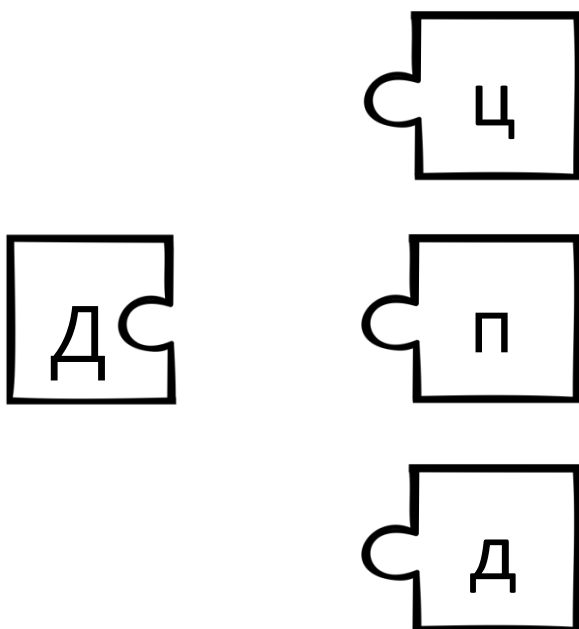

4 Обој слово д

д	ц	д	ц
ц	ц	д	ц
д	ц	д	ц

6 Заокружи све што почиње на слово д

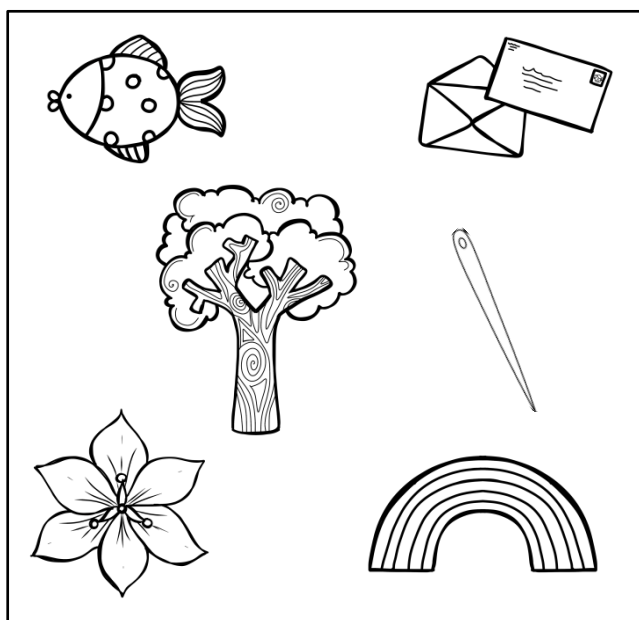

5 Означи бројевима 1,2,3

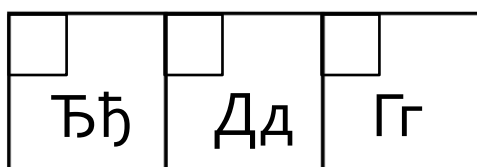

1 Обој

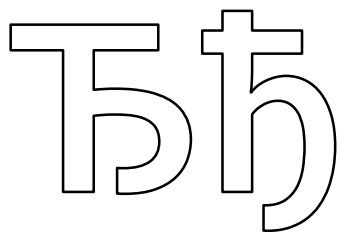

2 Допиши слово које недостаје

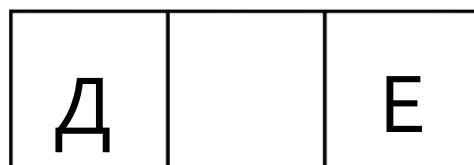
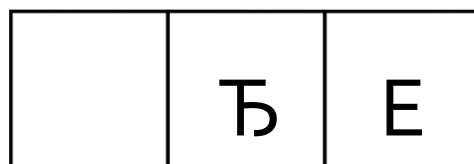
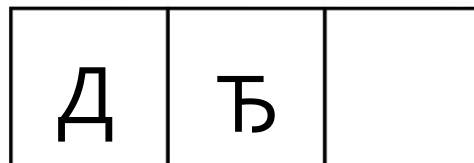

3 Повежи

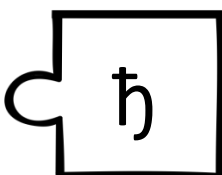
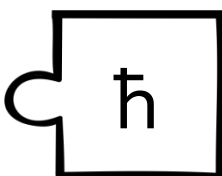
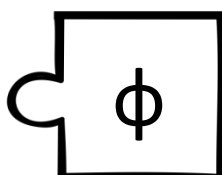
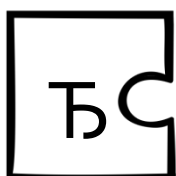

4 Обој слово ћ

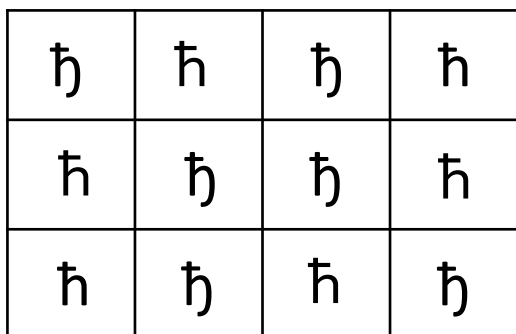

5 Означи бројевима 1,2,3

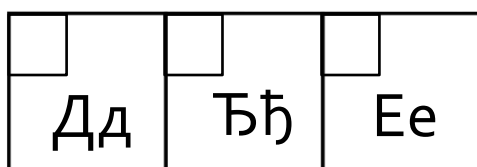

6 Заокружи све што почиње на слово ћ

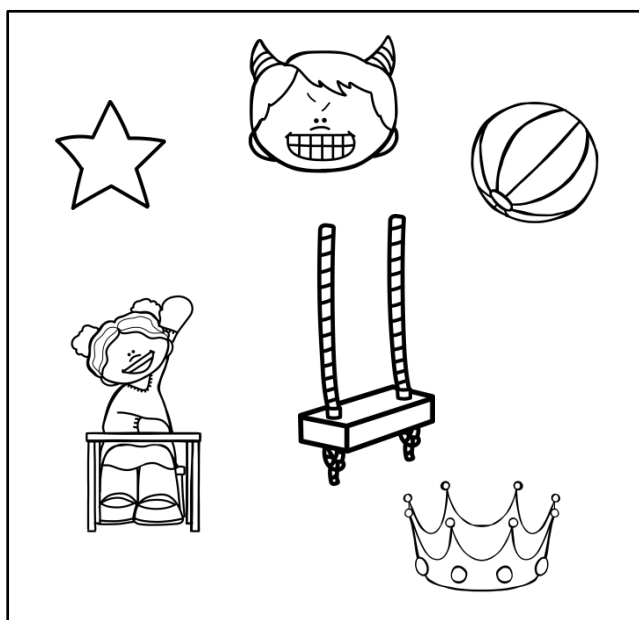

1 Обој

Ee

2 Допиши слово које недостаје

Д		Е
---	--	---

3 Повежи

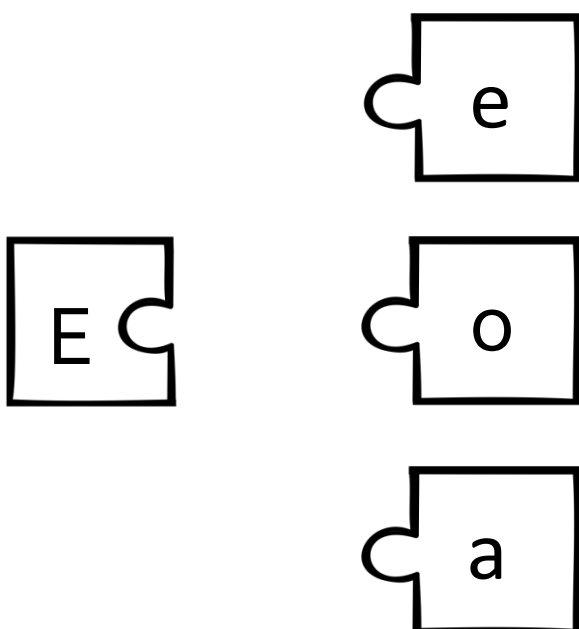

Д	Ђ	
---	---	--

	Ђ	Е
--	---	---

4 Обој слово е

е	е	а	а
а	е	е	а
е	а	е	а

6 Заокружи све што почиње на слово е

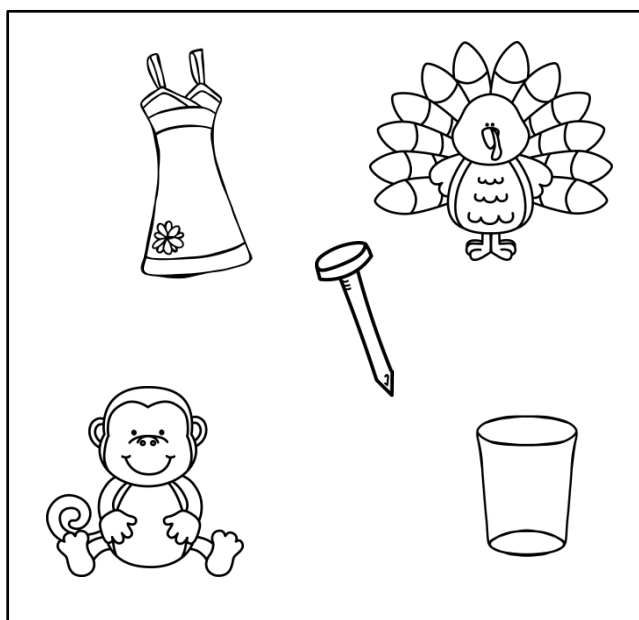

5 Означи бројевима 1,2,3

Ђђ	Ее	Дд
----	----	----

1 Обој

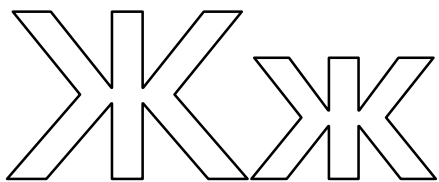

2 Допиши слово које недостаје

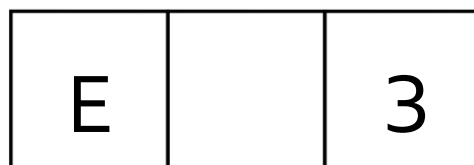
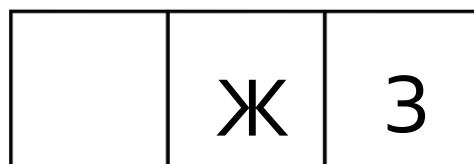
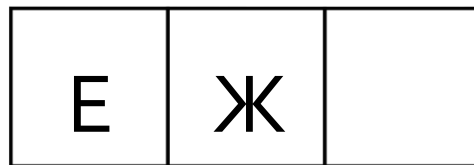

3 Повежи

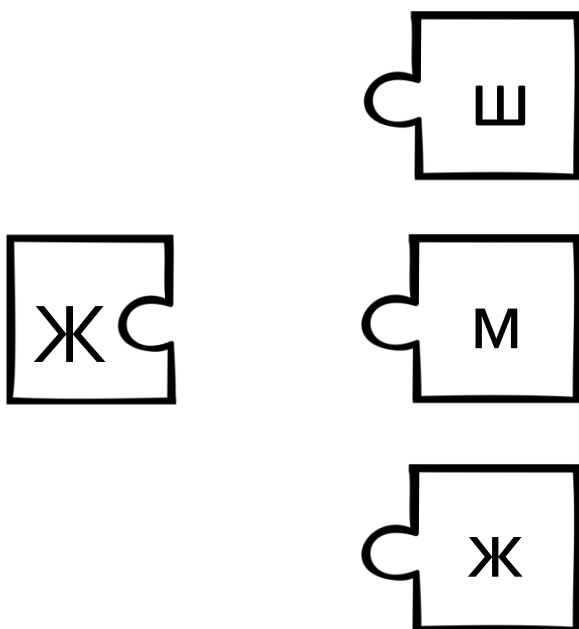

4 Обој слово ж

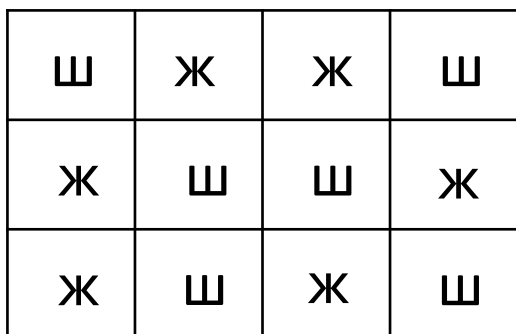

5 Означи бројевима 1,2,3

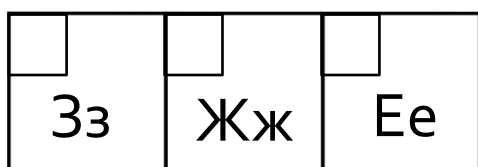

6 Заокружи све што почиње на слово Ж

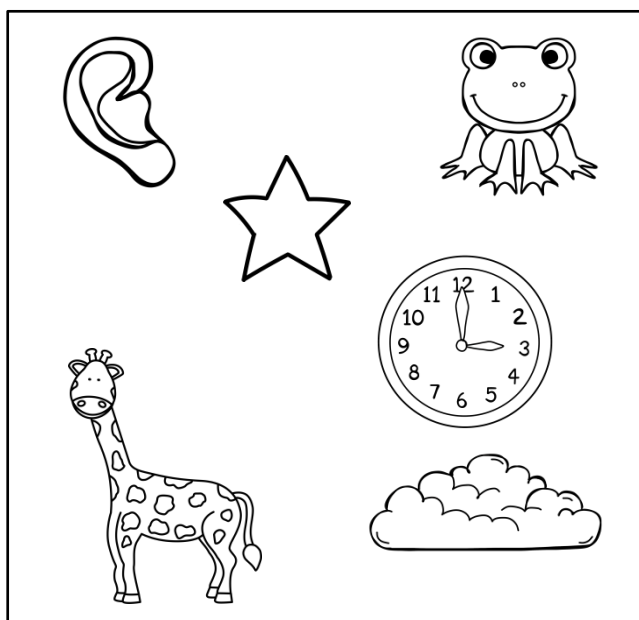

1 Обој

Зз

2 Допиши слово које недостаје

	з	и
--	---	---

3 Повежи

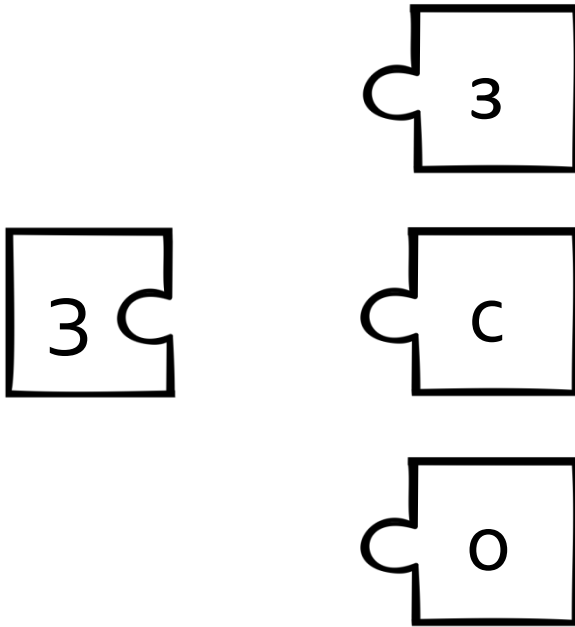

ж		и
---	--	---

ж	з	
---	---	--

4 Обој слово з

з	с	з	с
с	з	з	с
с	з	с	с

6 Заокружи све што почиње на слово з

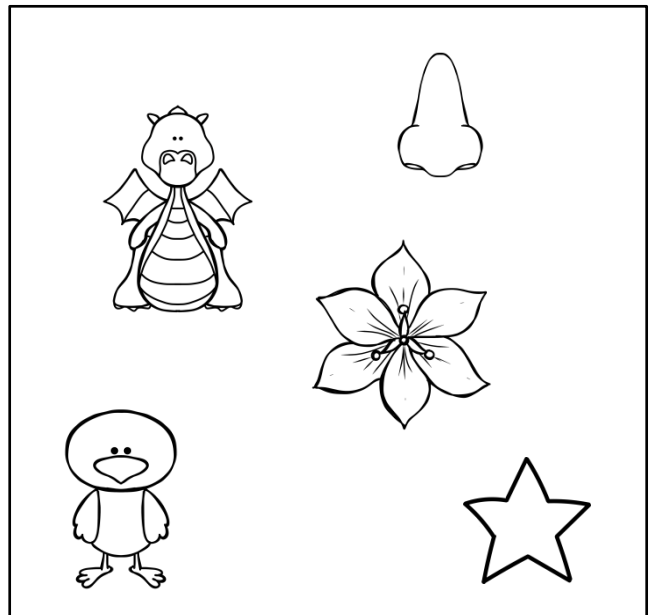

5 Означи бројевима 1,2,3

Ии	Зз	Жж
----	----	----

1 Обој

Ии

2 Допиши слово које недостаје

З		Ј
---	--	---

	И	Ј
--	---	---

З	И	
---	---	--

3 Повежи

Ис

п

и

н

4 Обој слово и

И	И	Н	Н
Н	И	Н	И
И	Н	И	Н

6 Заокружи све што почиње на слово и

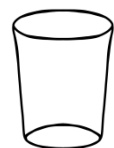
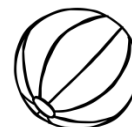
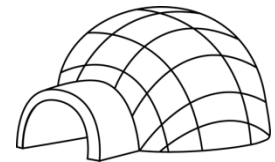

5 Означи бројевима 1,2,3

Ии	Јј	Зз
----	----	----

1 Обој

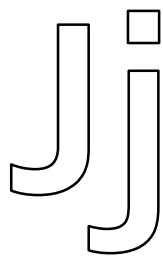

2 Допиши слово које недостаје

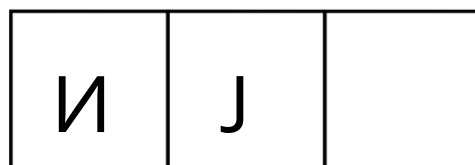
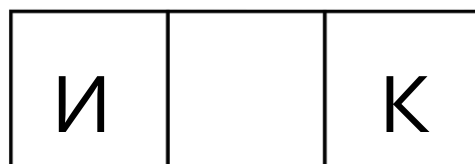
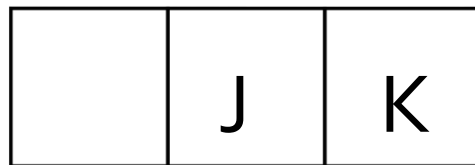

3 Повежи

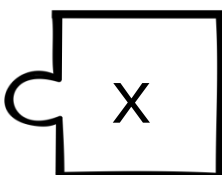
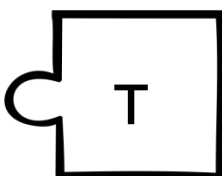
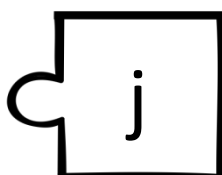
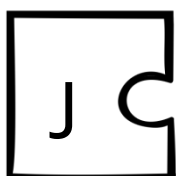

4 Обој слово ј

Т	ј	Т	Т
Т	ј	ј	Т
ј	Т	ј	Т

5 Означи бројевима 1,2,3

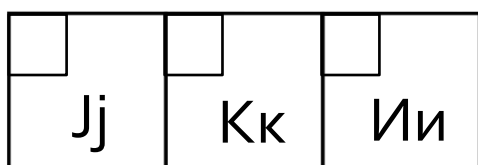

6 Заокружи све што почиње на слово ј

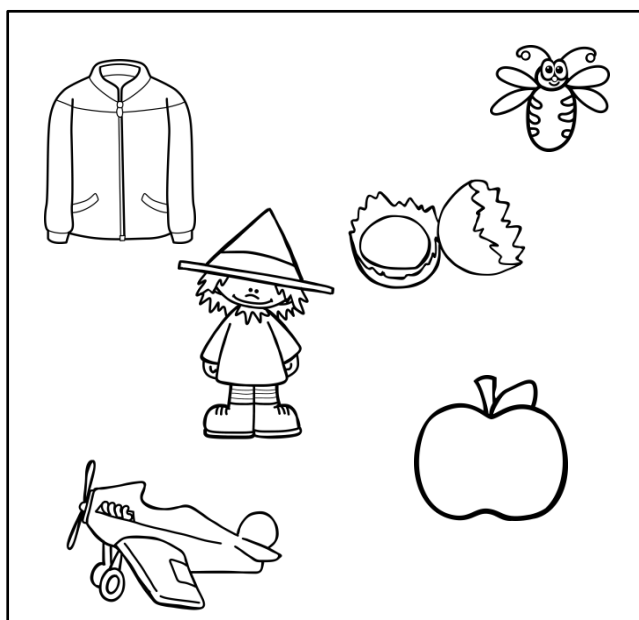

1 Обој

Кк

2 Допиши слово које недостаје

И		Л
---	--	---

3 Повежи

К	С
---	---

Х

К

Н

И	К	
---	---	--

	К	Л
--	---	---

4 Обој слово к

К	Х	К	Х
Х	Х	К	К
К	Х	Х	К

5 Означи бројевима 1,2,3

Кк	Ии	Лл
----	----	----

6 Заокружи све што почиње на слово к

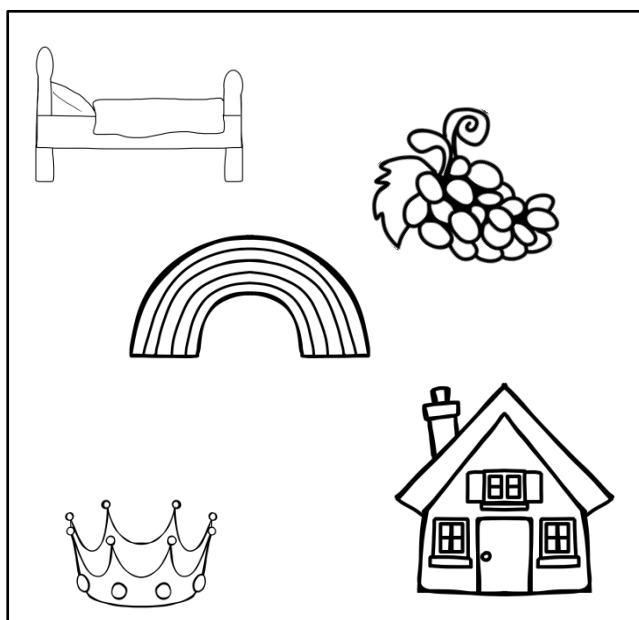

1 Обој

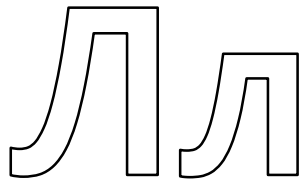

2 Допиши слово које недостаје

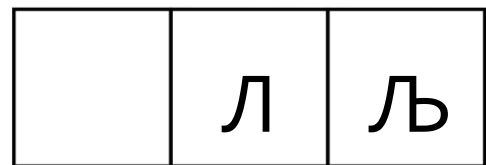
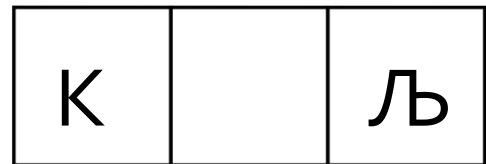
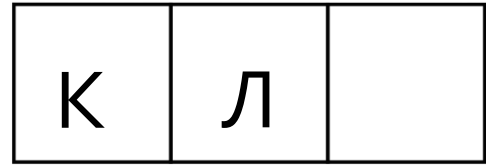

3 Повежи

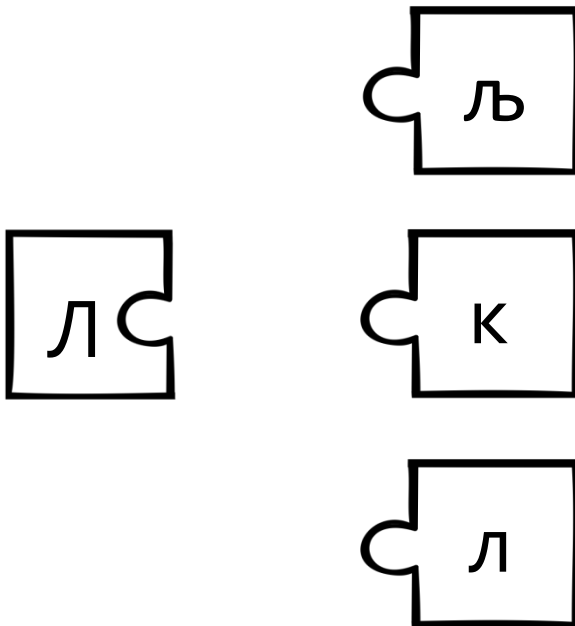

4 Обој слово Л

л	љ	л	љ
л	љ	љ	л
љ	л	л	љ

5 Означи бројевима 1,2,3

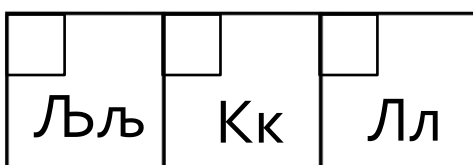

6 Заокружи све што почиње на слово Л

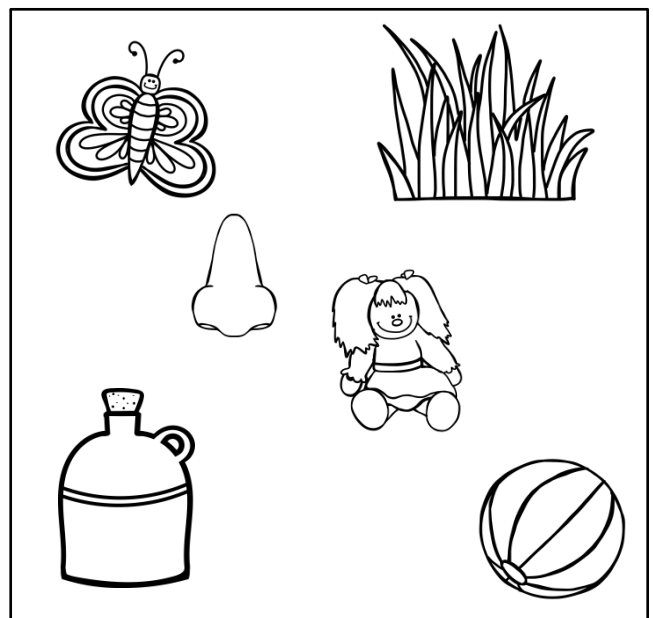

1 Обој

Љ љ

2 Допиши слово које недостаје

	љ	м
--	---	---

3 Повежи

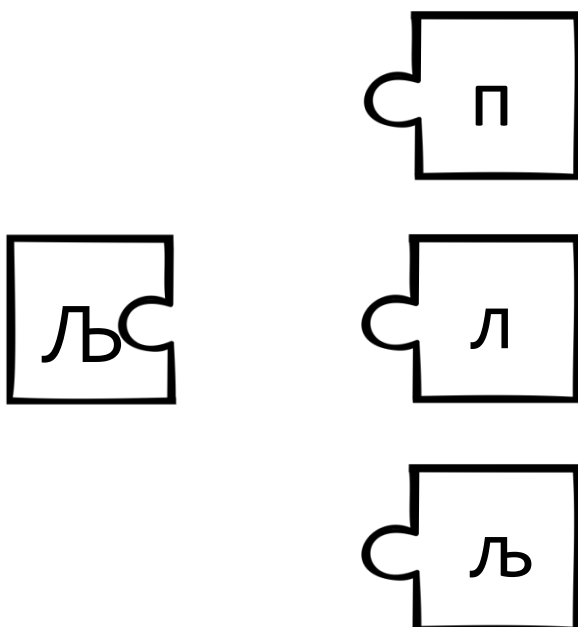

л	љ	
---	---	--

л		м
---	--	---

4 Обој слово љ

љ	љ	л	л
л	л	љ	л
л	л	л	љ

6 Заокружи све што почиње на слово љ

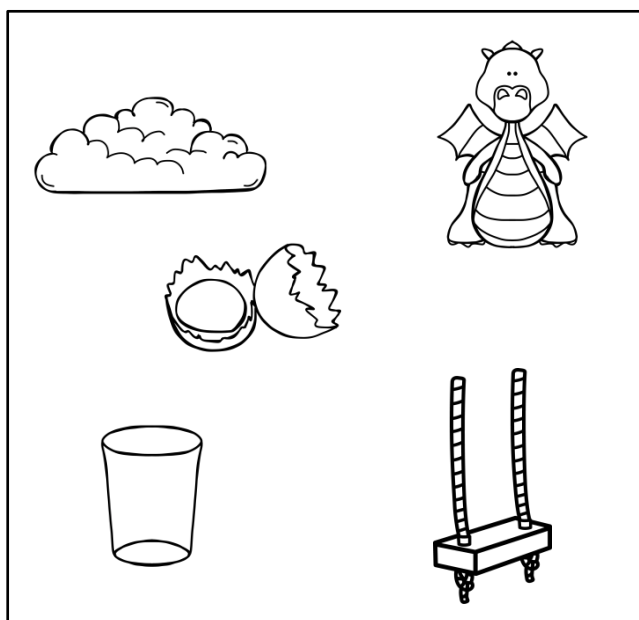

5 Означи бројевима 1,2,3

Мм	Лл	Љљ

1 Обој

ММ

2 Допиши слово које недостаје

Љ	М	
---	---	--

	М	Н
--	---	---

Љ		Н
---	--	---

3 Повежи

М	С
---	---

И

М

Н

4 Обој слово м

М	Н	Н	М
Н	М	М	Н
М	Н	М	Н

6 Заокружи све што почиње на слово м

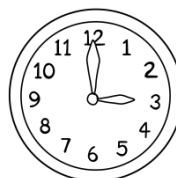
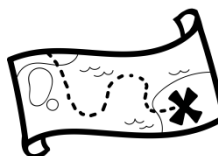

5 Означи бројевима 1,2,3

Нн	Љљ	Мм

1 Обој

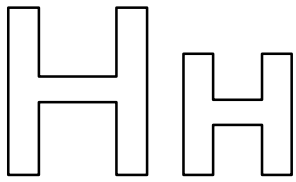

2 Допиши слово које недостаје

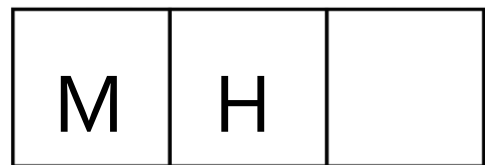
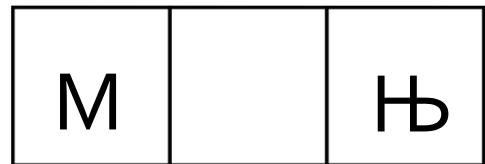
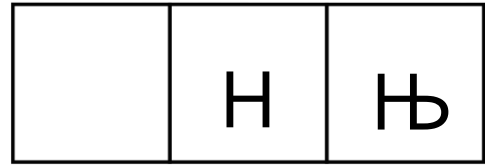

3 Повежи

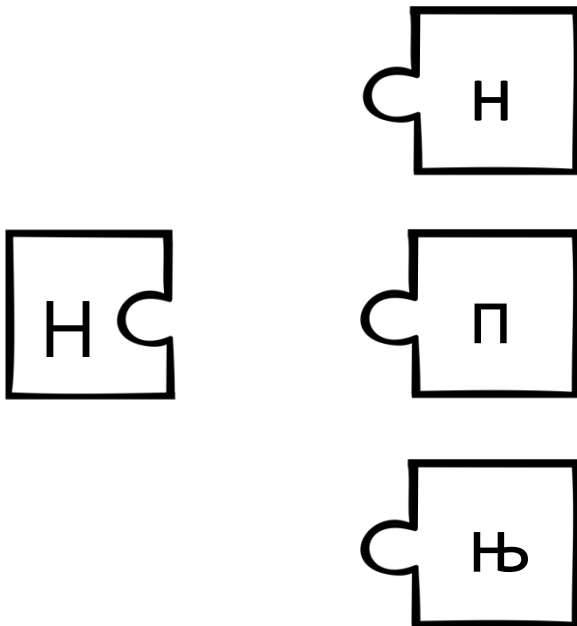

4 Обој слово н

Н	Њ	Н	Њ
Њ	Н	Н	Њ
Н	Њ	Њ	Н

5 Означи бројевима 1,2,3

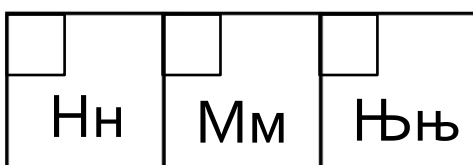

6 Заокружи све што почиње на слово н

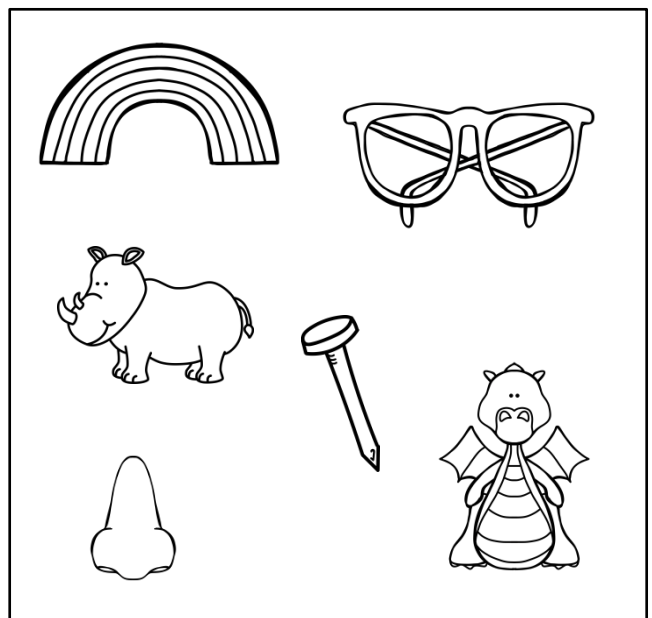

1 Обој

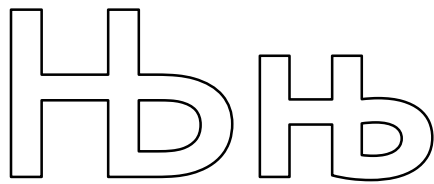

2 Допиши слово које недостаје

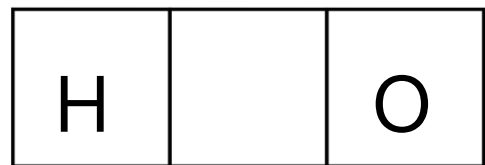
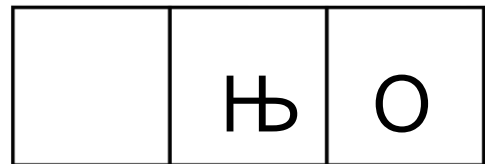
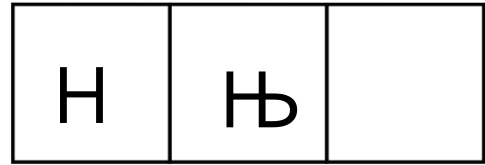

3 Повежи

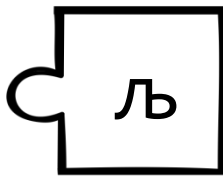
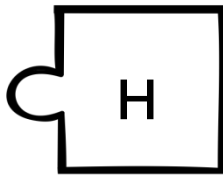
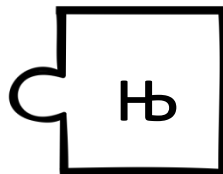

4 Обој слово њ

њ	љ	њ	љ
њ	њ	љ	љ
љ	њ	њ	њ

5 Означи бројевима 1,2,3

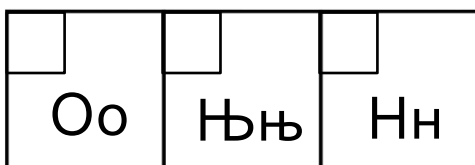

6 Заокружи све што почиње на слово њ

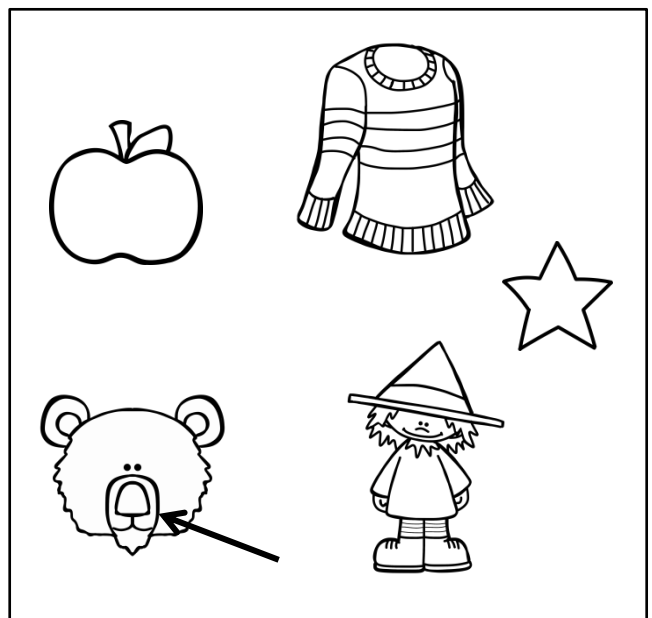

1 Обој

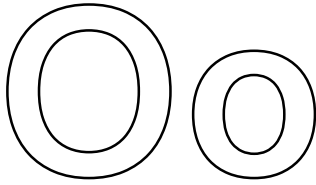

2 Допиши слово које недостаје



3 Повежи

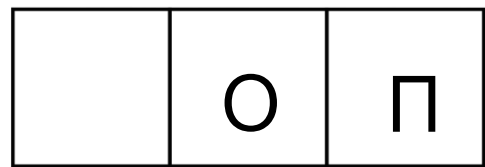
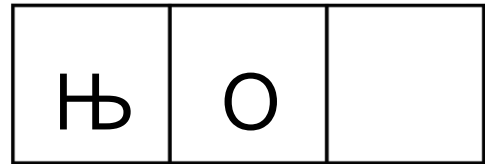
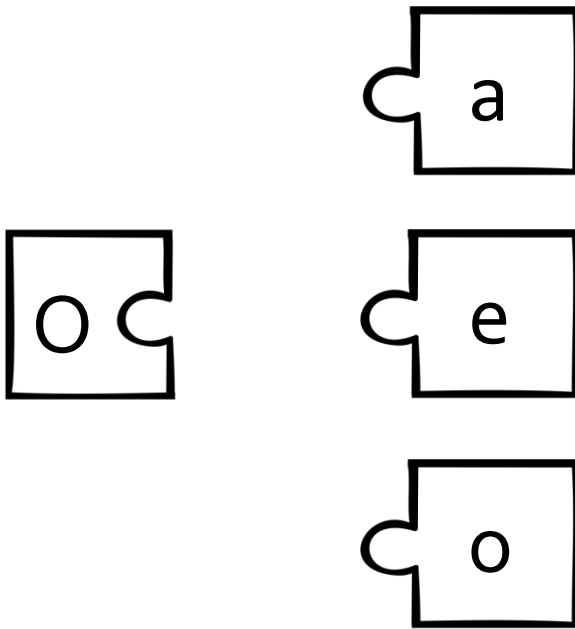

4 Обој слово о

а	о	а	о
а	о	о	а
о	о	о	а

6 Заокружи све што почиње на слово о

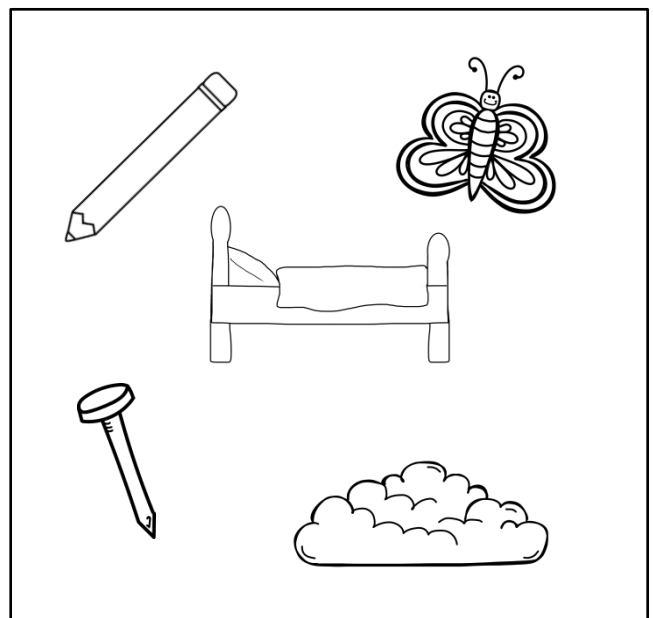

5 Означи бројевима 1,2,3

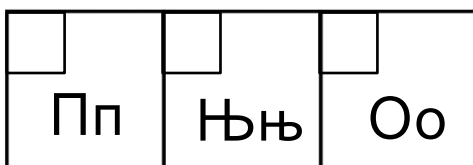

1 Обој

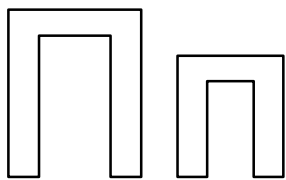

2 Допиши слово које недостаје

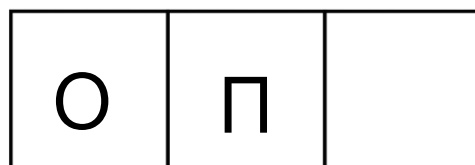
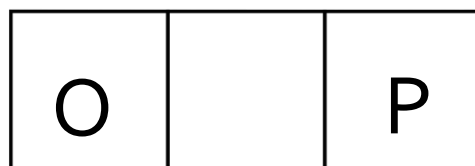
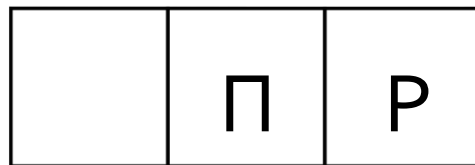

3 Повежи

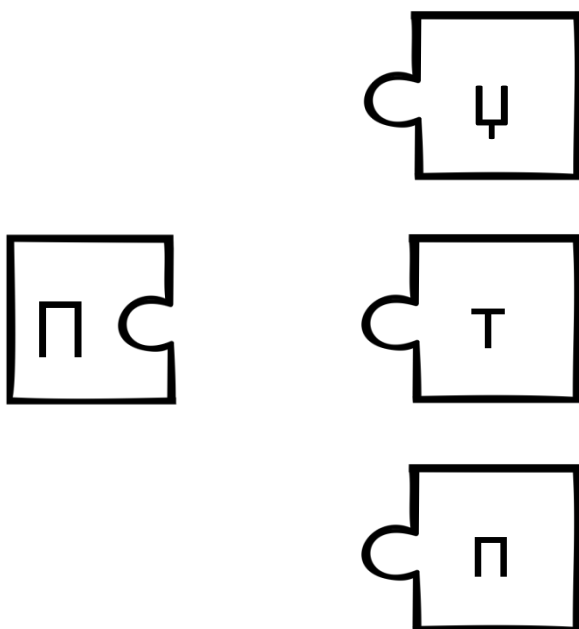

4 Обој слово п

п	п	т	т
т	п	п	т
п	т	п	т

6 Заокружи све што почиње на слово п

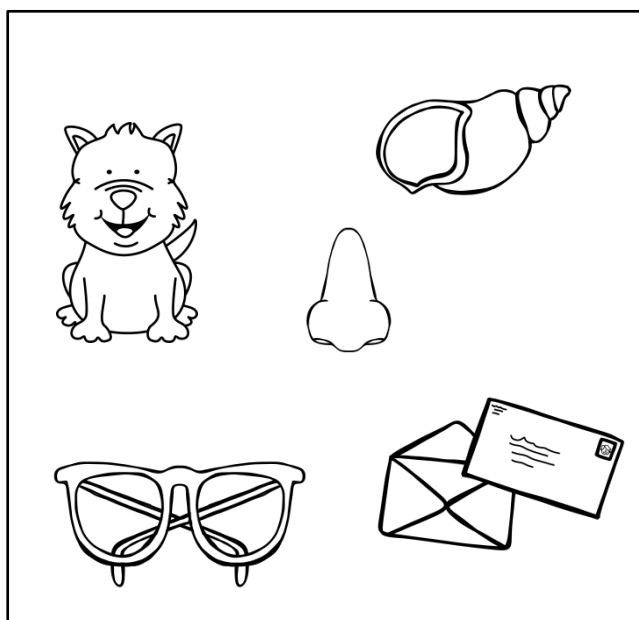

5 Означи бројевима 1,2,3

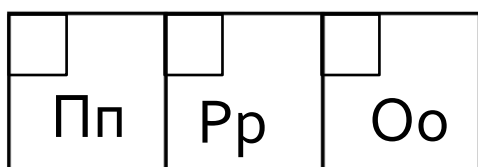

1 Обој

Р р

2 Допиши слово које недостаје

п	р	
---	---	--

	р	с
--	---	---

п		с
---	--	---

3 Повежи

р	с
---	---

б

р

ф

4 Обој слово р

б	р	р	б
р	б	р	б
б	б	р	р

6 Заокружи све што почиње на слово р

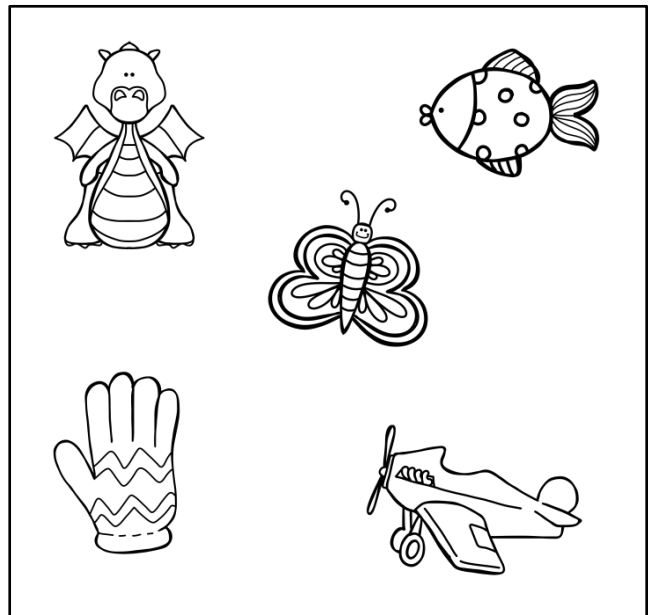

5 Означи бројевима 1,2,3

Рр	Пп	Сс

1 Обој



2 Допиши слово које недостаје

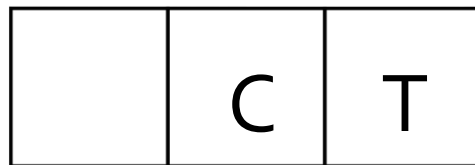

3 Повежи

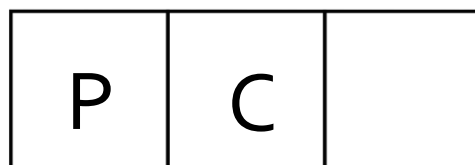
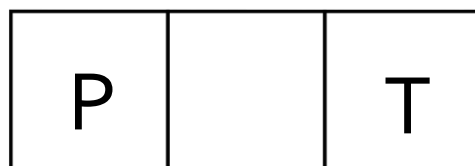
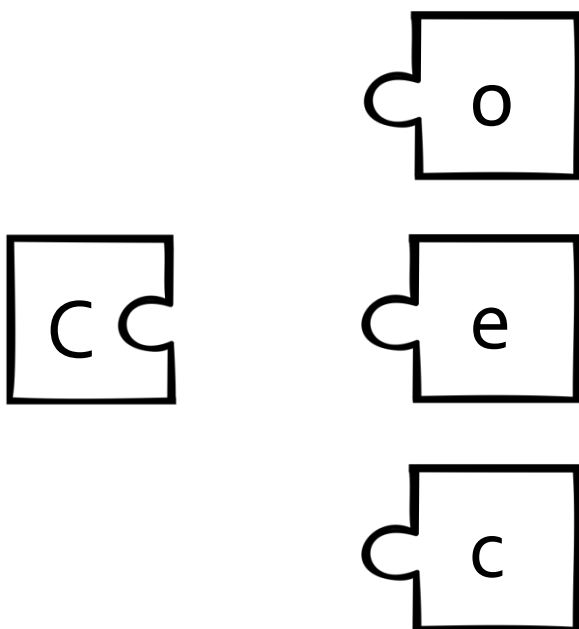

4 Обој слово с

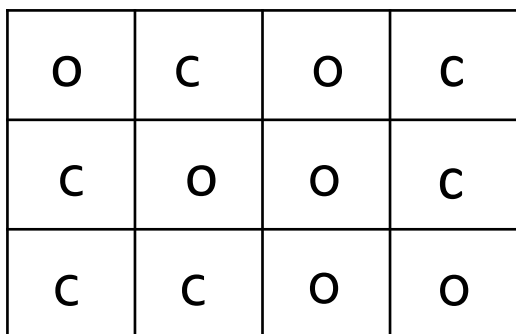

6 Заокружи све што почиње на слово с

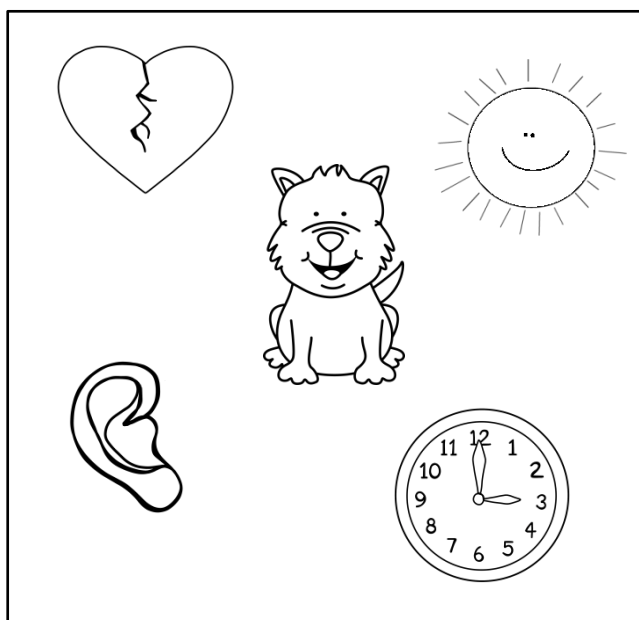

5 Означи бројевима 1,2,3

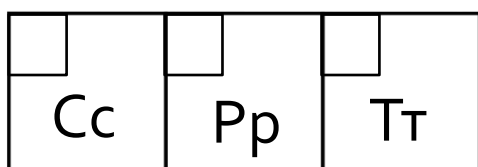

1 Обој

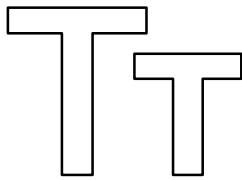

2 Допиши слово које недостаје

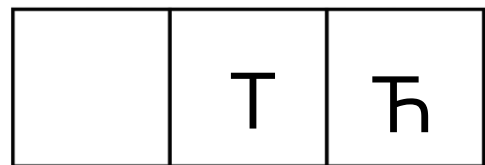
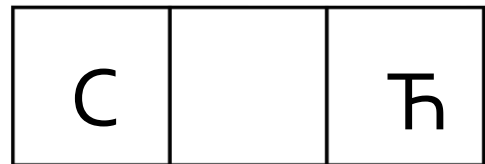
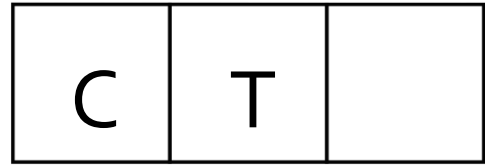

3 Повежи

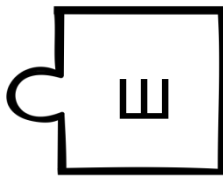
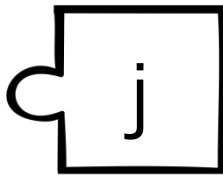
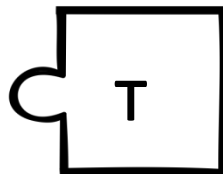
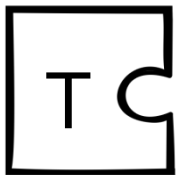

4 Обој слово т

т	т	ш	т
ш	ш	т	т
ш	т	т	ш

5 Означи бројевима 1,2,3

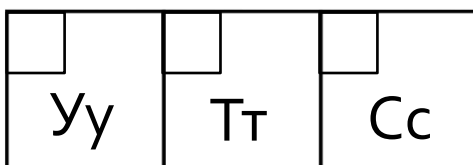

6 Заокружи све што почиње на слово т

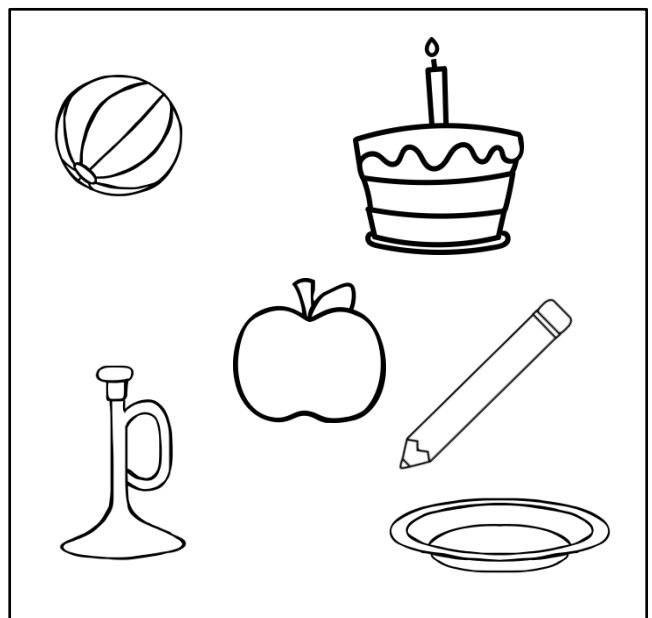

1 Обој

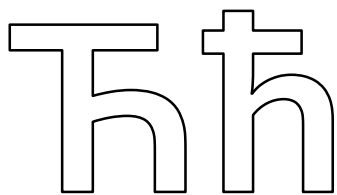

2 Допиши слово које недостаје

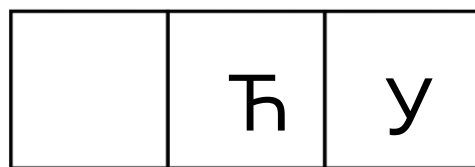
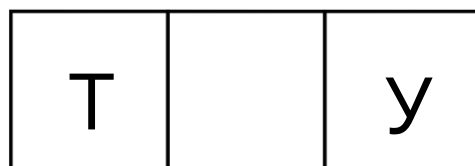
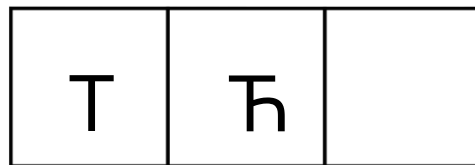

3 Повежи

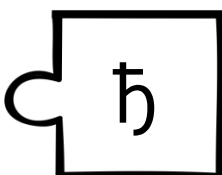
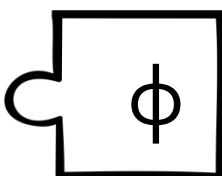
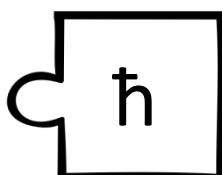
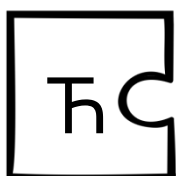

4 Обој слово ћ

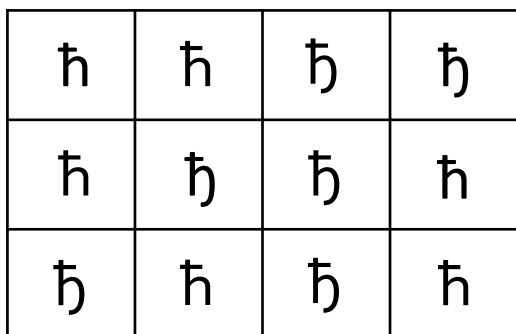

5 Означи бројевима 1,2,3

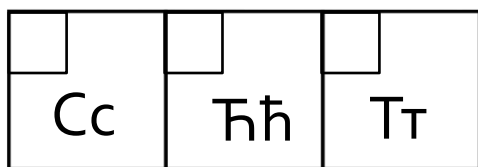

6 Заокружи све што почиње на слово ћ

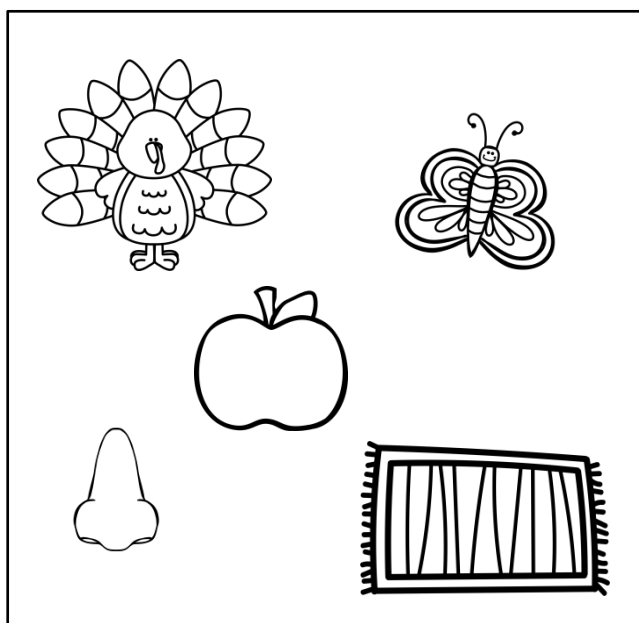

1 Обој

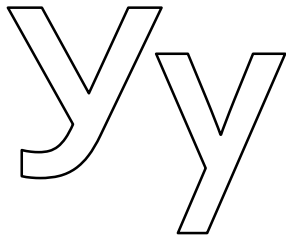

2 Допиши слово које недостаје

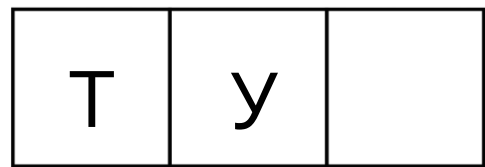
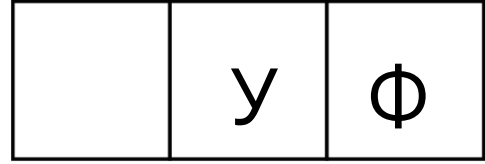

3 Повежи

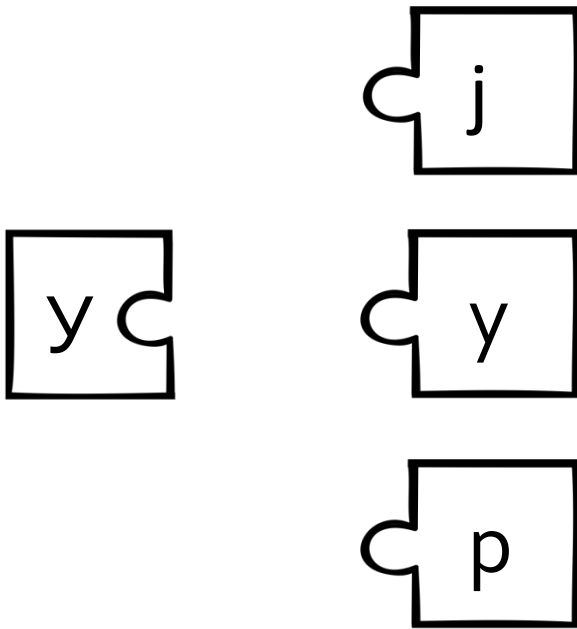

4 Обој слово у

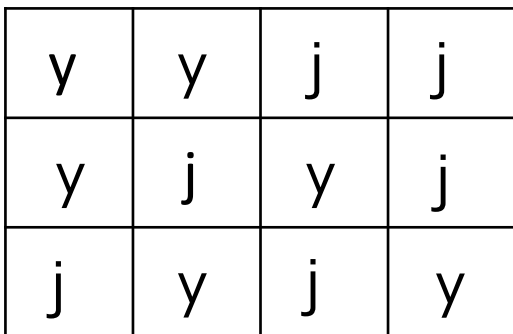

5 Означи бројевима 1,2,3

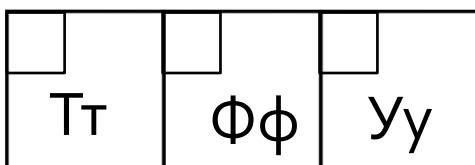

6 Заокружи све што почиње на слово у

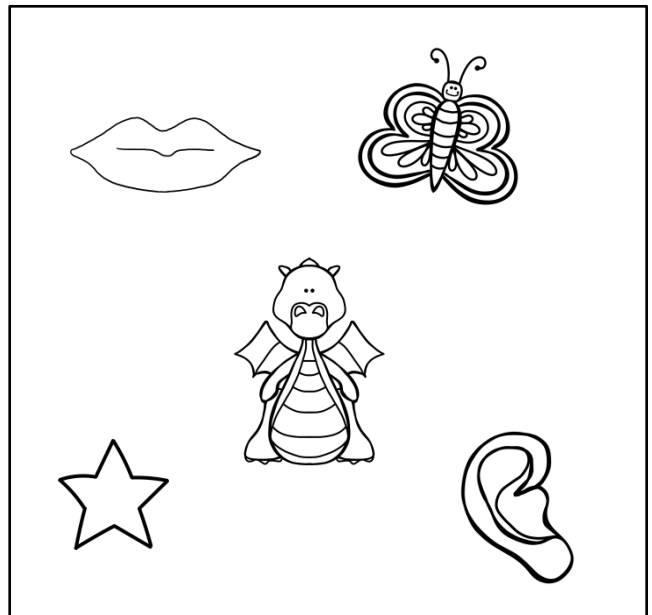

1 Обој

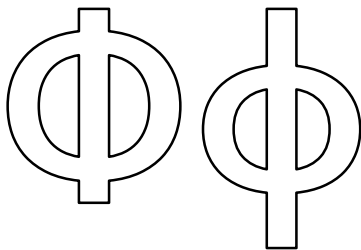

2 Допиши слово које недостаје

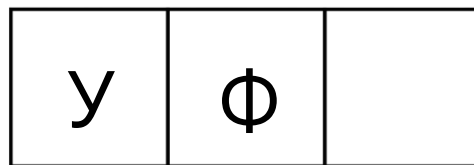
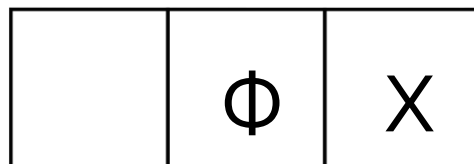
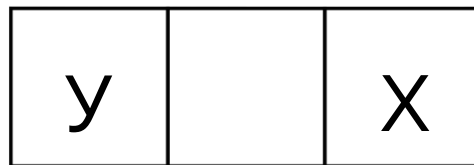

3 Повежи

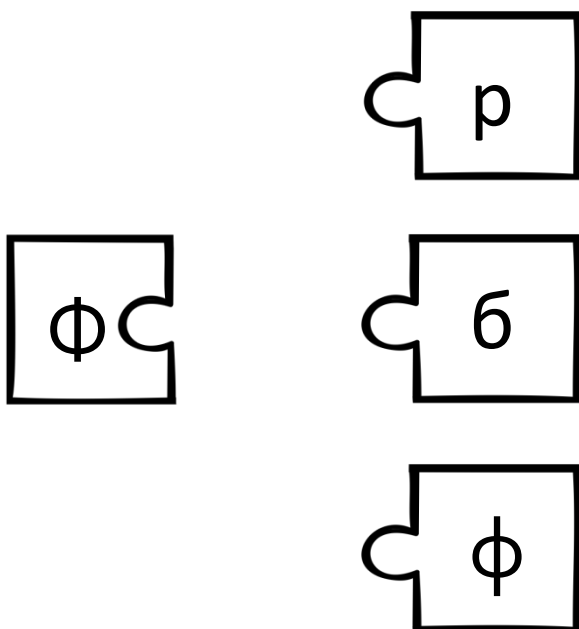

4 Обој слово ф

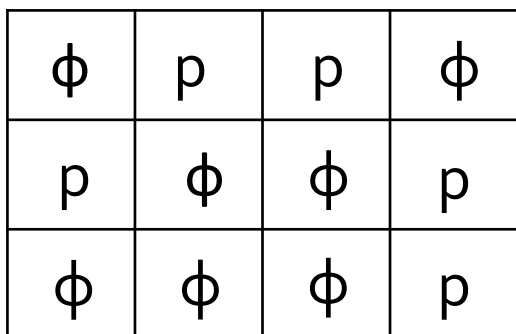

6 Заокружи све што почиње на слово ф

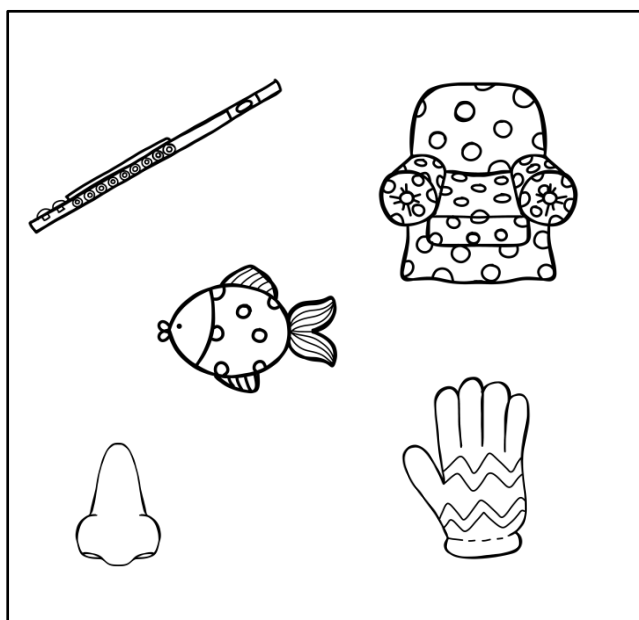

5 Означи бројевима 1,2,3

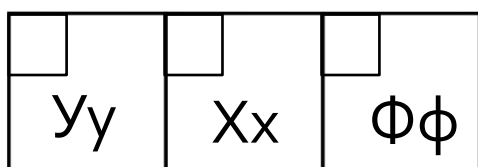

1 Обој

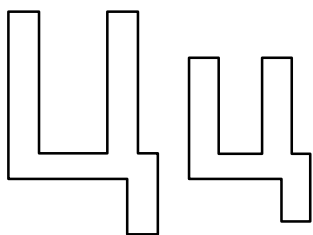

2 Допиши слово које недостаје

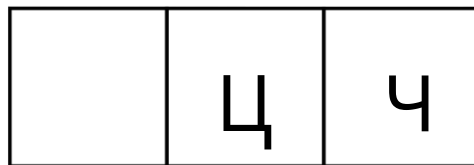

3 Повежи

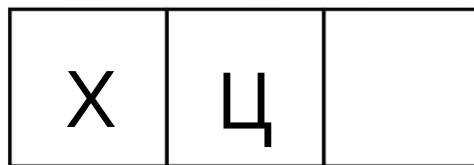
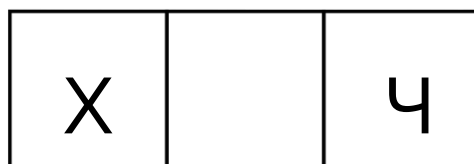
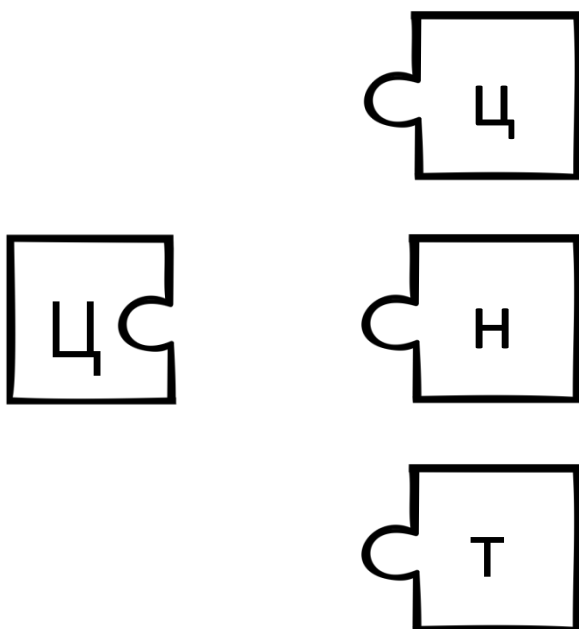

4 Обој слово ц

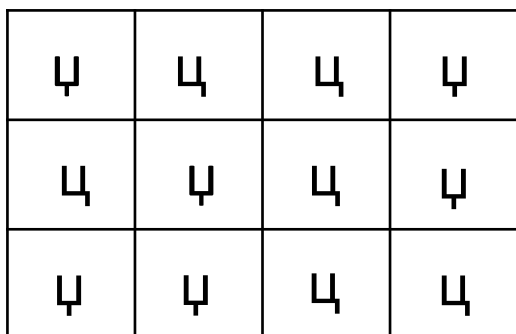

6 Заокружи све што почиње на слово ц

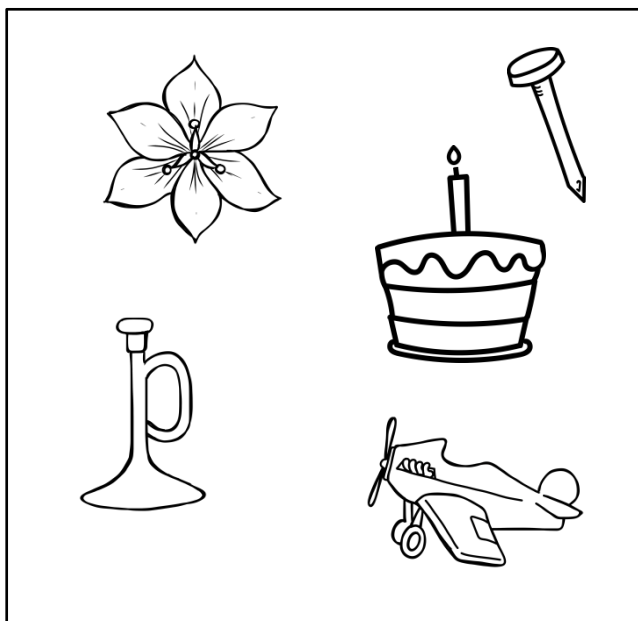

5 Означи бројевима 1,2,3

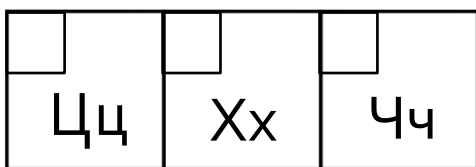

1 Обој

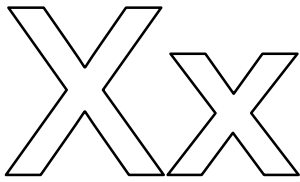

2 Допиши слово које недостаје

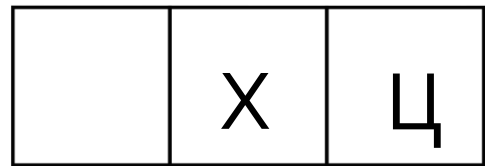
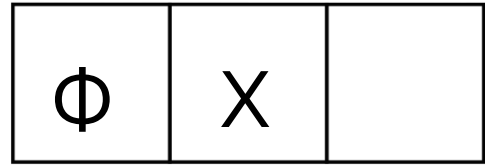

3 Повежи

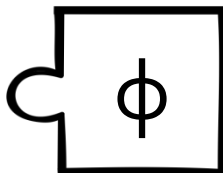
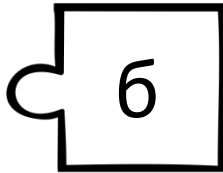
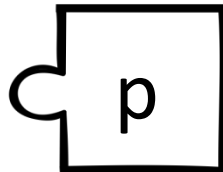
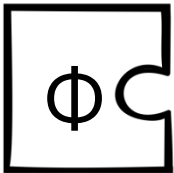

4 Обој слово х

х	ж	х	ж
ж	х	х	ж
ж	х	ж	х

6 Заокружи све што почиње на слово х

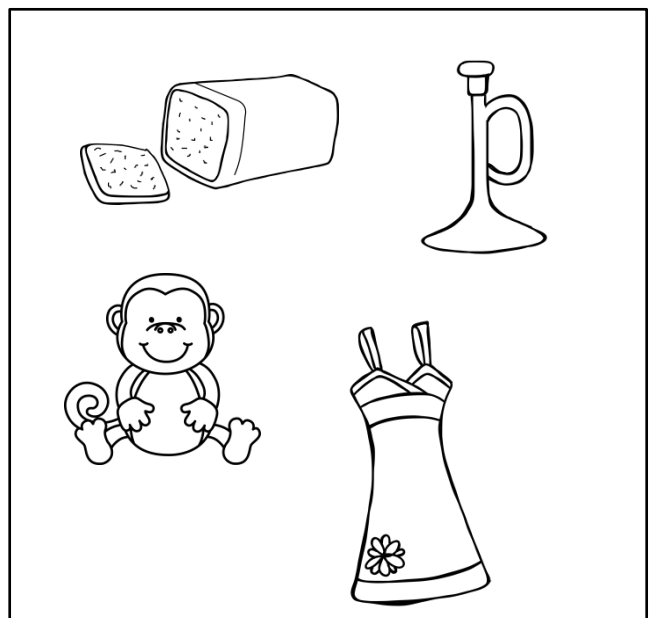

5 Означи бројевима 1,2,3

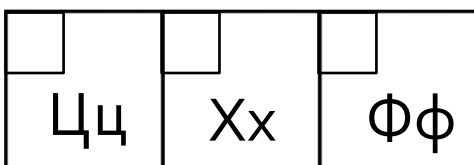

1 Обој

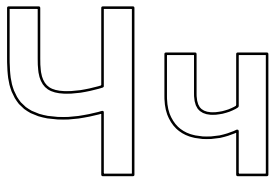

2 Допиши слово које недостаје

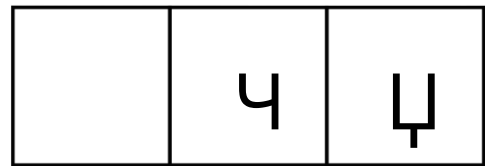
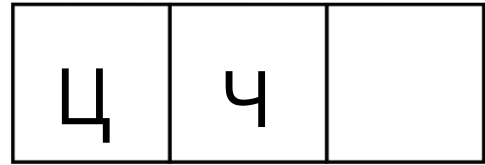

3 Повежи

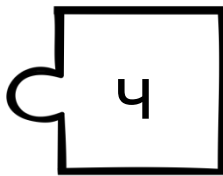
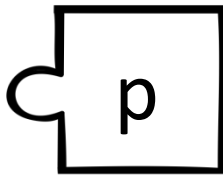
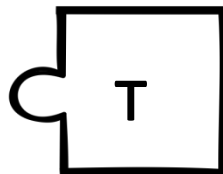
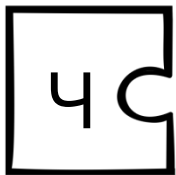

4 Обој слово ч

ч	р	ч	р
р	ч	ч	р
ч	ч	р	р

6 Заокружи све што почиње на слово ч

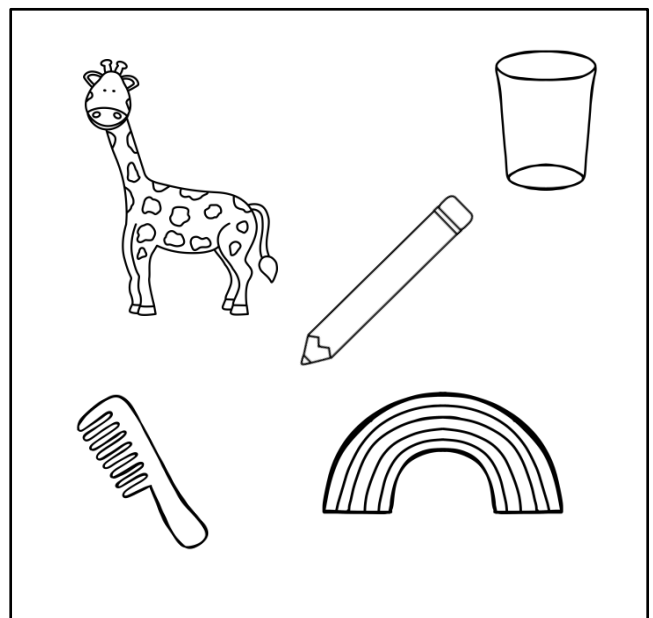

5 Означи бројевима 1,2,3

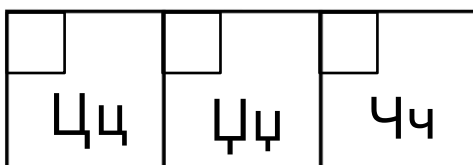

1 Обој

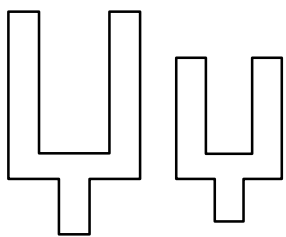

2 Допиши слово које недостаје

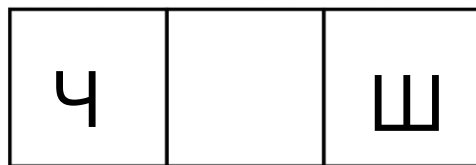
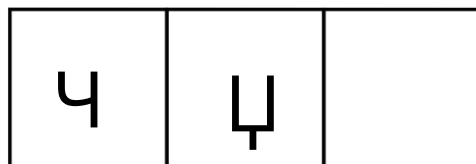
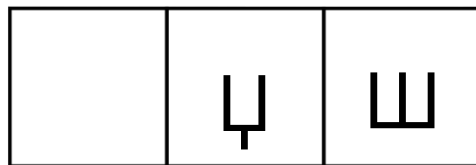

3 Повежи

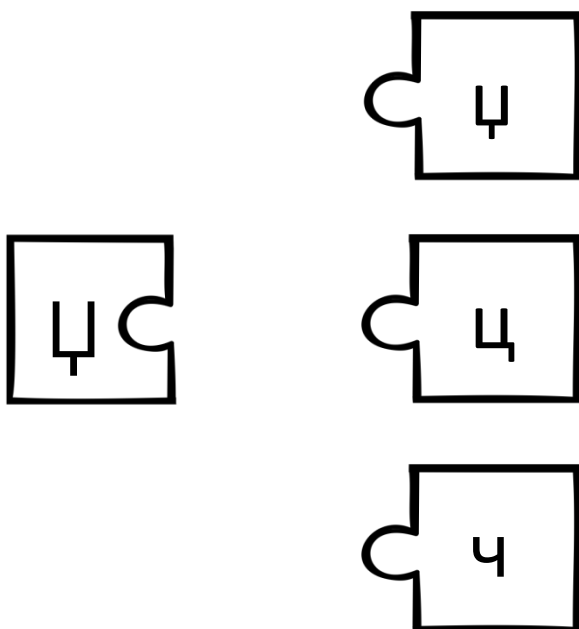

4 Обој слово ц

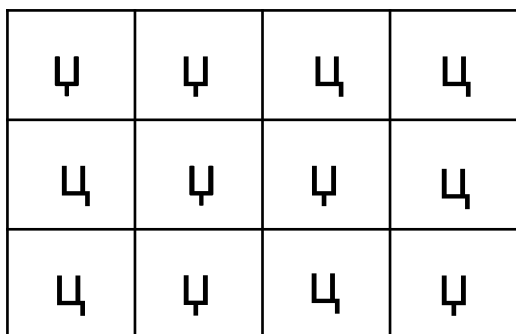

5 Означи бројевима 1,2,3

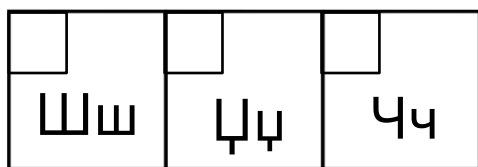

6 Заокружи све што почиње на слово ц

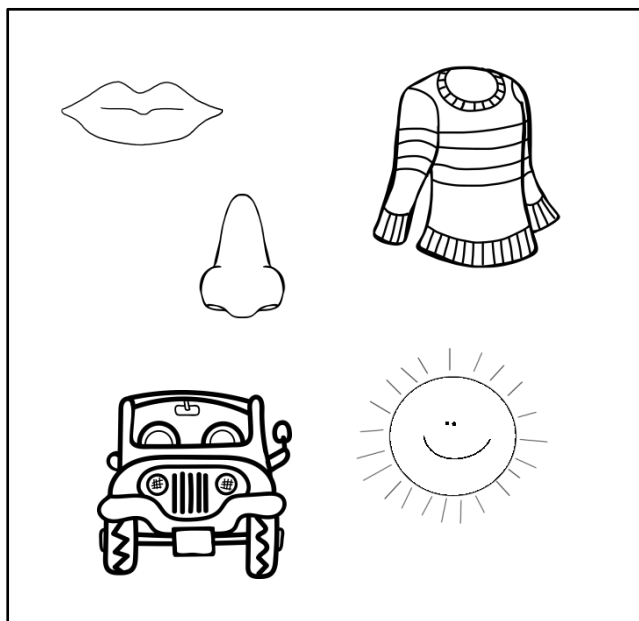

1 Обој

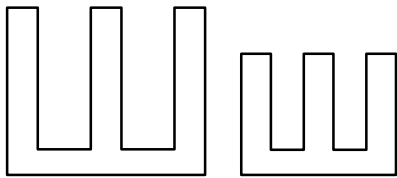

2 Допиши слово које недостаје

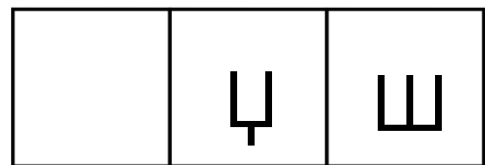
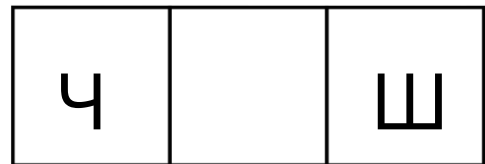
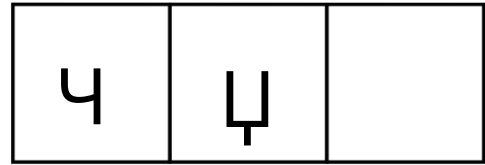

3 Повежи

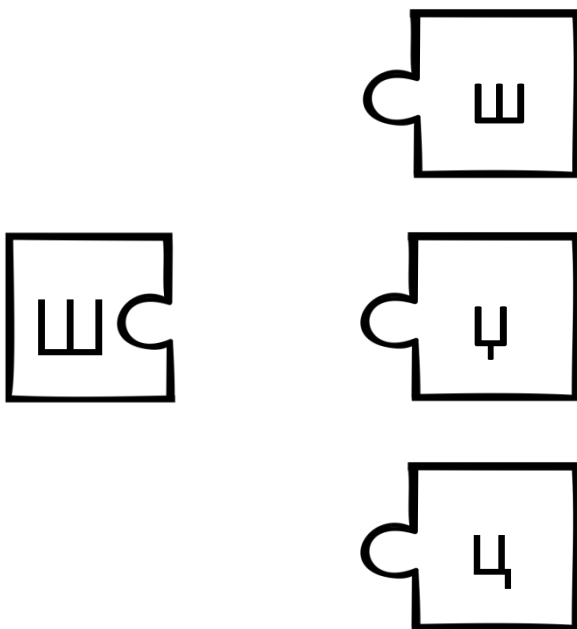

4 Обој слово ш

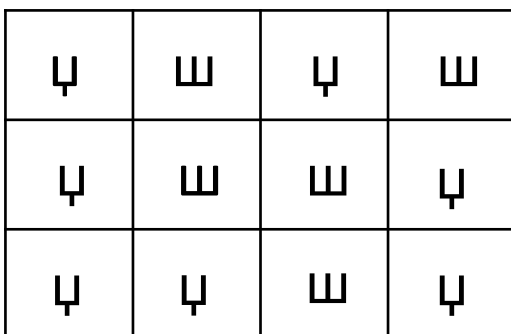



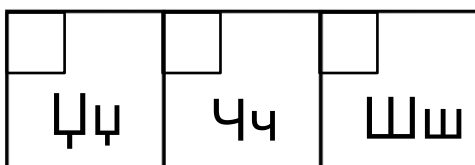



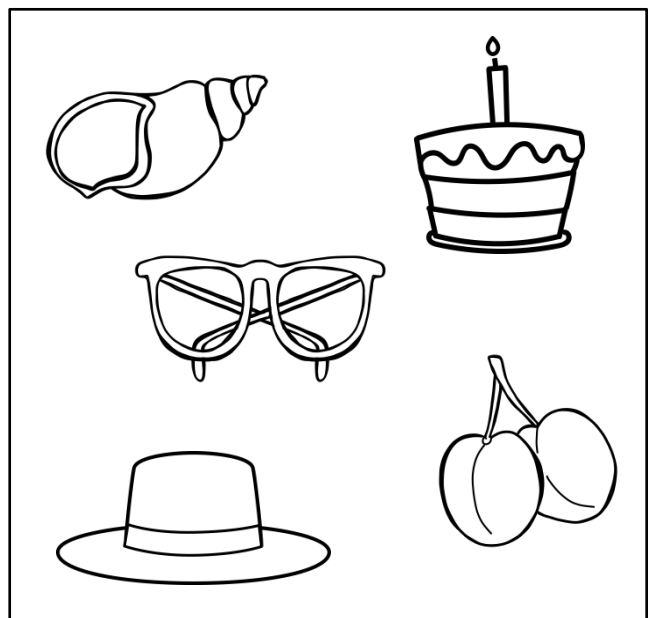

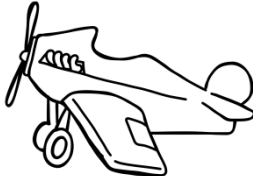
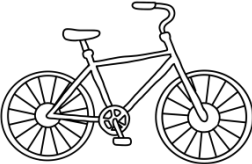
5 Означи бројевима 1,2,3



6 Заокружи све што почиње на слово ш

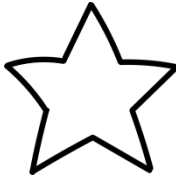

<p>почетак</p>	<p>Аа</p>		<p>Бб</p>
	<p>Вв</p>		<p>Гг</p>
	<p>Дд</p>		<p>Ђђ</p>
	<p>Ее</p>		<p>Жж</p>
	<p>Зз</p>		<p>Ии</p>
	<p>Јј</p>		<p>Кк</p>



Лл

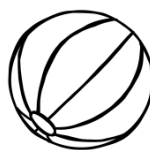

Льль

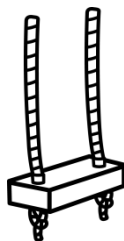

Мм



Нн



Ньнь

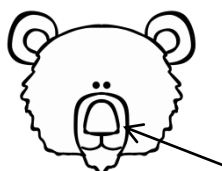

Оо



Пп



Рр

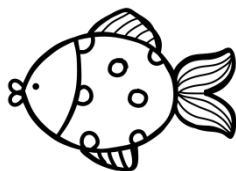

Сс

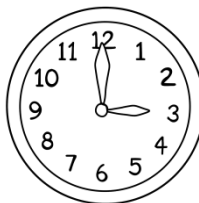

Тт



Ъћ

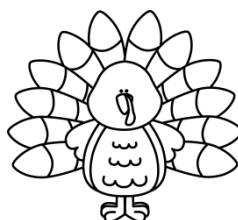

Уу



Фф



Xx



Цц



Чч



Чч

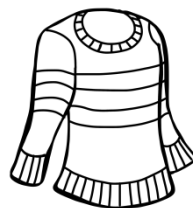

Шш



крај

1 Обој

Аа

2 Допиши слово које недостаје

А	Б	В
---	---	---

А	Б	В
---	---	---

А	Б	В
---	---	---

3 Повежи

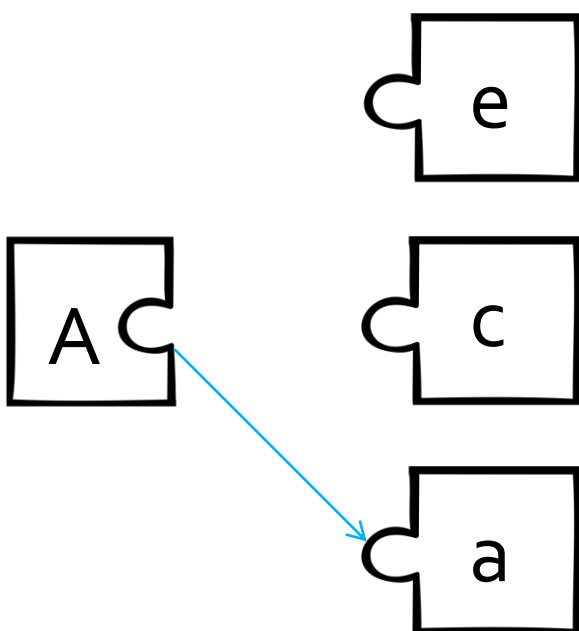

4 Обоји слово а

а	е	с	а
е	а	а	с
с	а	е	а

5 Означи бројевима 1,2,3

3	1	2
Вв	Аа	Бб

6 Заокружи све што почиње на слово а

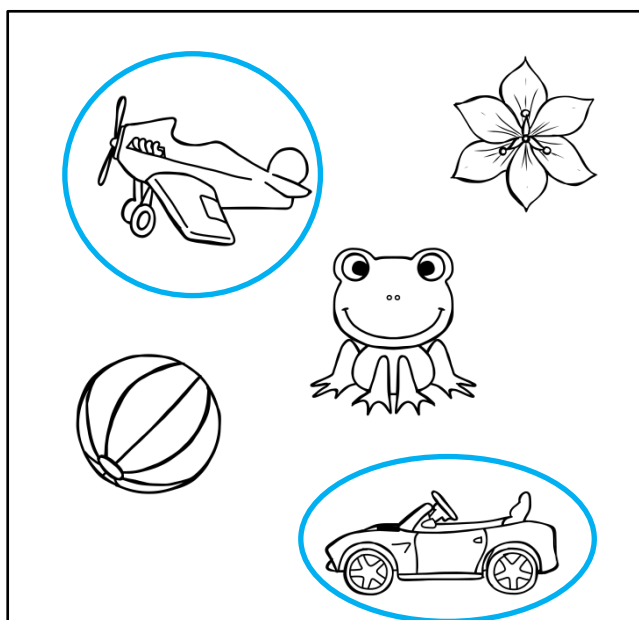

1 Обој

Бб

2 Допиши слово које недостаје

А	Б	В
---	---	---

3 Повежи

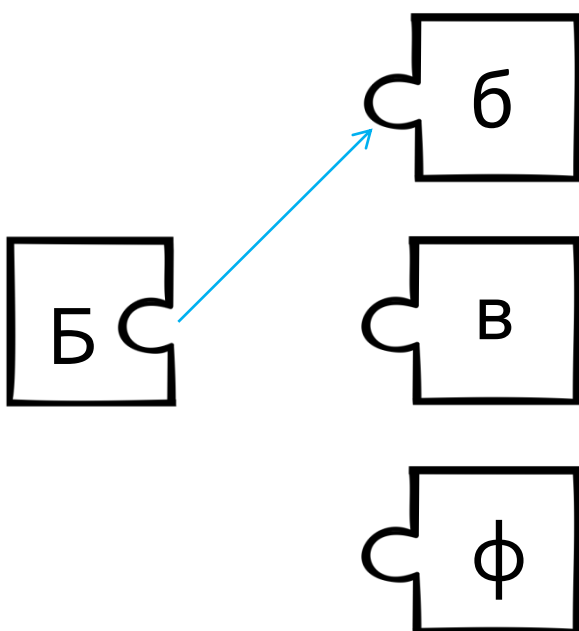

А	Б	В
---	---	---

А	Б	В
---	---	---

4 Обој слово б

б	р	б	ф
ф	б	б	р
б	ф	р	б

6 Заокружи све што почиње на слово б

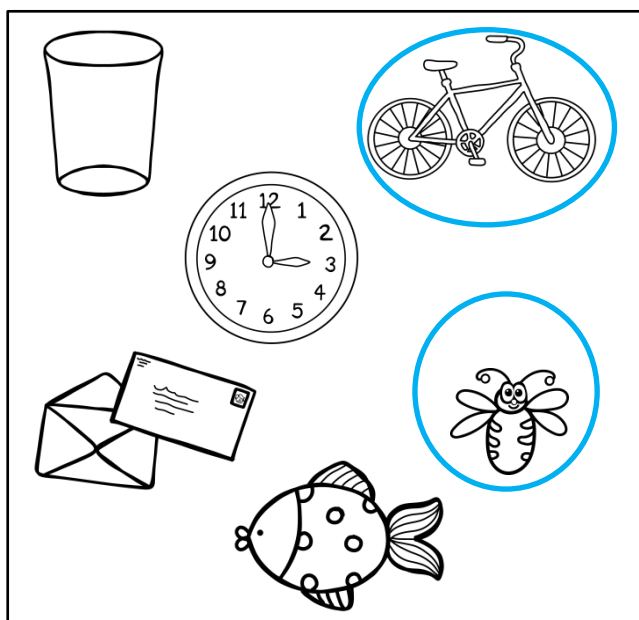

5 Означи бројевима 1,2,3

2	1	3
Бб	Аа	Вв

1 Обој

В В

2 Допиши слово које недостаје

Б	В	Г
---	---	---

Б	В	Г
---	---	---

Б	В	Г
---	---	---

3 Повежи

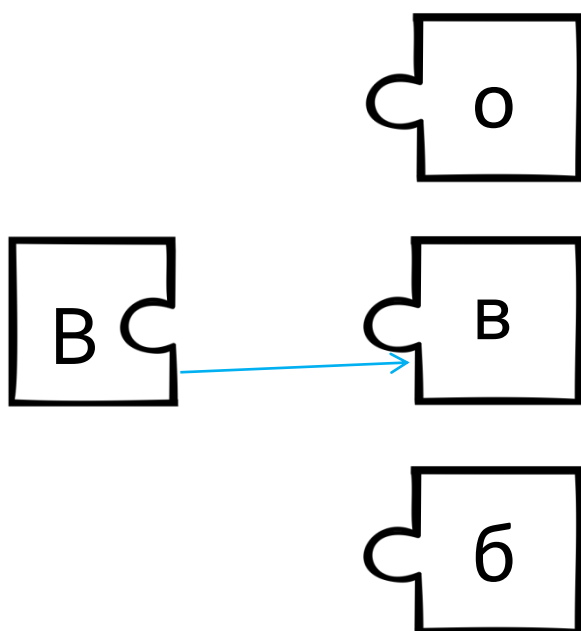

4 Обој слово в

б	в	в	б
ф	в	ф	в
в	б	в	в

6 Заокружи све што почиње на слово в

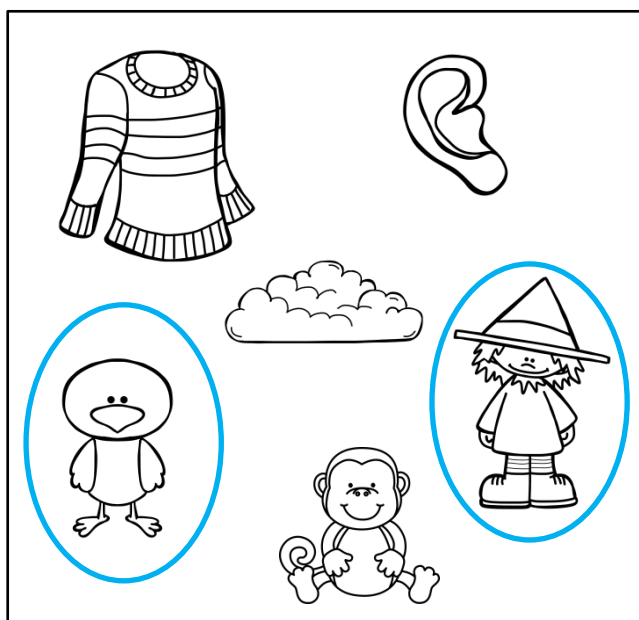

5 Означи бројевима 1,2,3

2	3	1
Бб	Вв	Аа

1 Обој

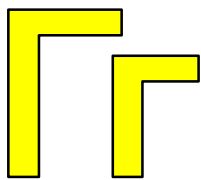

2 Допиши слово које недостаје

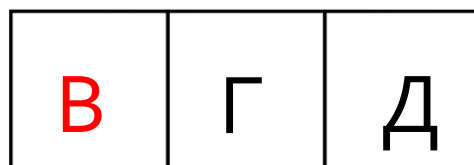
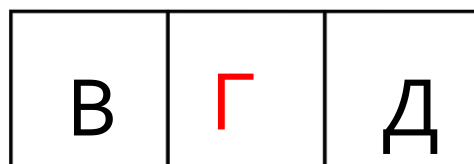
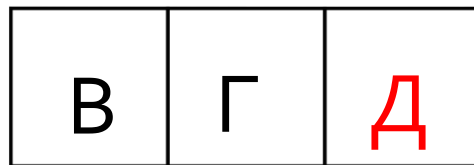

3 Повежи

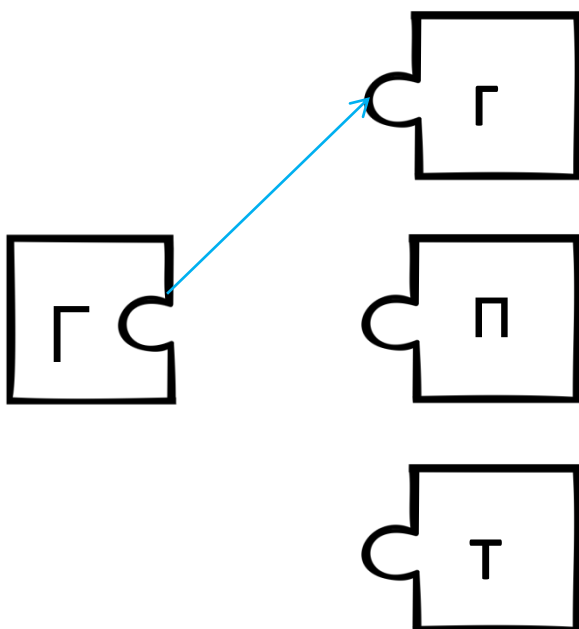

4 Обој слово г

Т	Г	Т	Г
Г	Т	Т	Г
Г	Г	Т	Т

5 Означи бројевима 1,2,3

2	1	3
ГГ	ВВ	ДД

6 Заокружи све што почиње на слово Г

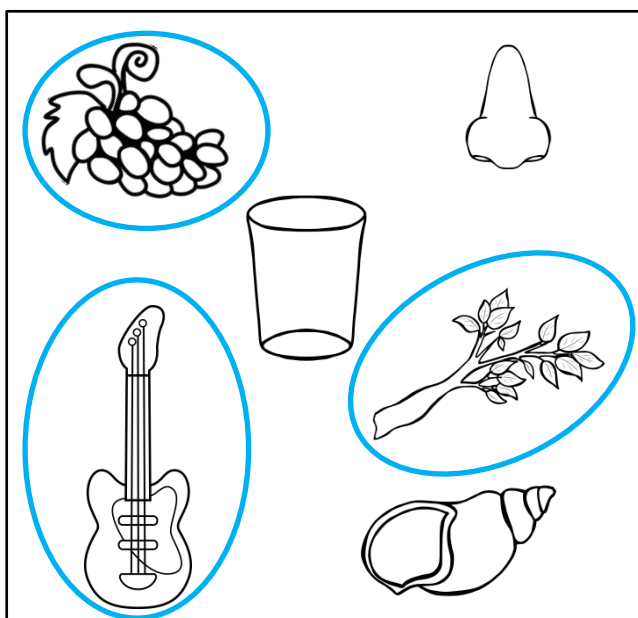

1 Обој

ДД

2 Допиши слово које недостаје

Г	Д	Ђ
---	---	---

Г	Д	Ђ
---	---	---

Г	Д	Ђ
---	---	---

3 Повежи

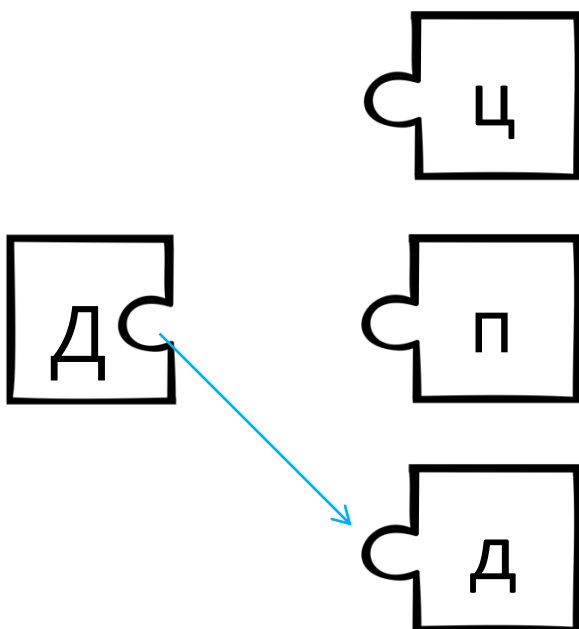

4 Обој слово д

д	ц	д	ц
ц	ц	д	ц
д	ц	д	ц

6 Заокружи све што почиње на слово д

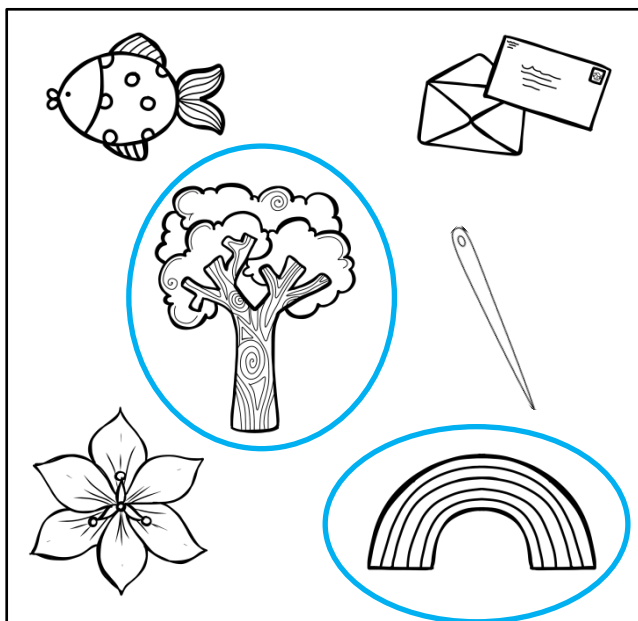

5 Означи бројевима 1,2,3

2	1	3
Ђђ	Дд	Гг

1 Обој

Ђђ

2 Допиши слово које недостаје

Д	Ђ	Е
---	---	---

Д	Ђ	Е
---	---	---

Д	Ђ	Е
---	---	---

3 Повежи

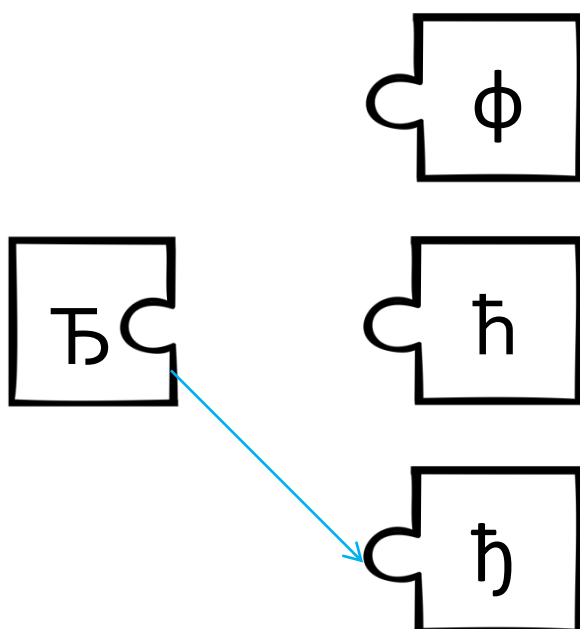

4 Обој слово ћ

ћ	ћ	ћ	ћ
ћ	ћ	ћ	ћ
ћ	ћ	ћ	ћ

5 Означи бројевима 1,2,3

1	2	3
Дд	Ђђ	Ее

6 Заокружи све што почиње на слово ћ

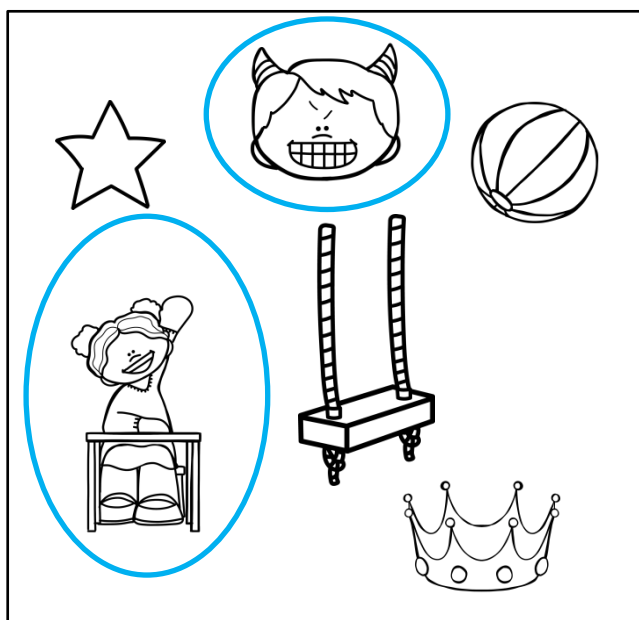

1 Обој

Ее

2 Допиши слово које недостаје

Д	Ђ	Е
---	---	---

Д	Ђ	Е
---	---	---

Д	Ђ	Е
---	---	---

3 Повежи

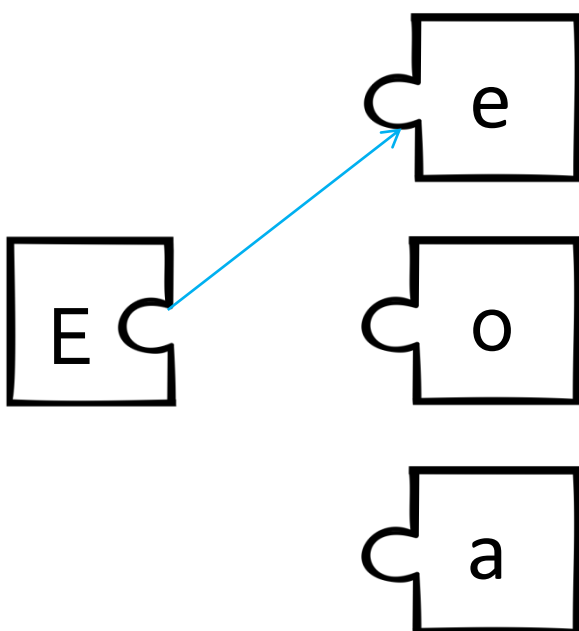

4 Обој слово е

е	е	а	а
а	е	е	а
е	а	е	а

6 Заокружи све што почиње на слово е

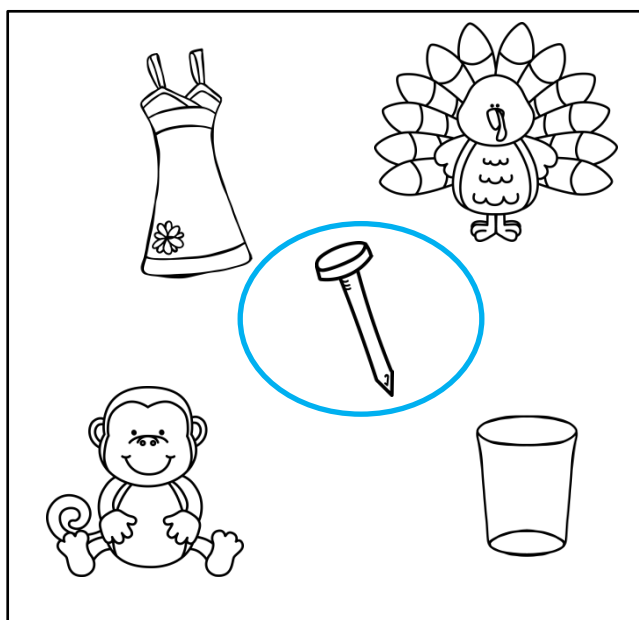

5 Означи бројевима 1,2,3

2	3	1
Ђђ	Ее	Дд

1 Обој

Жж

2 Допиши слово које недостаје

Е	Ж	З
---	---	---

3 Повежи

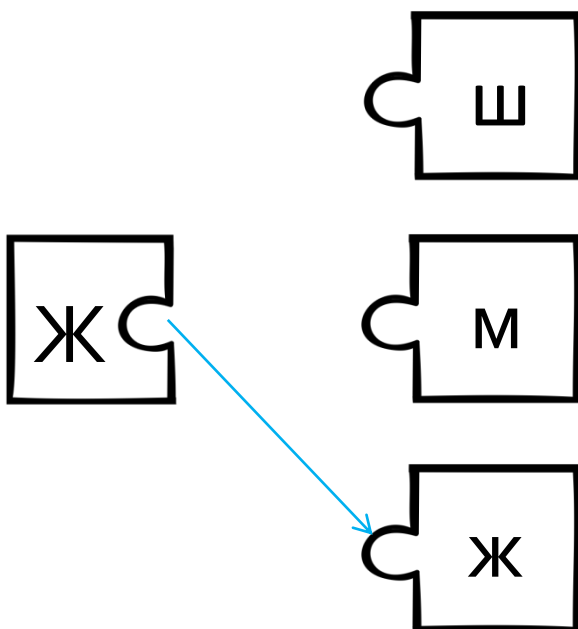

Е	Ж	З
---	---	---

Е	Ж	З
---	---	---

4 Обој слово ж

Ш	Ж	Ж	Ш
Ж	Ш	Ш	Ж
Ж	Ш	Ж	Ш

6 Заокружи све што почиње на слово Ж

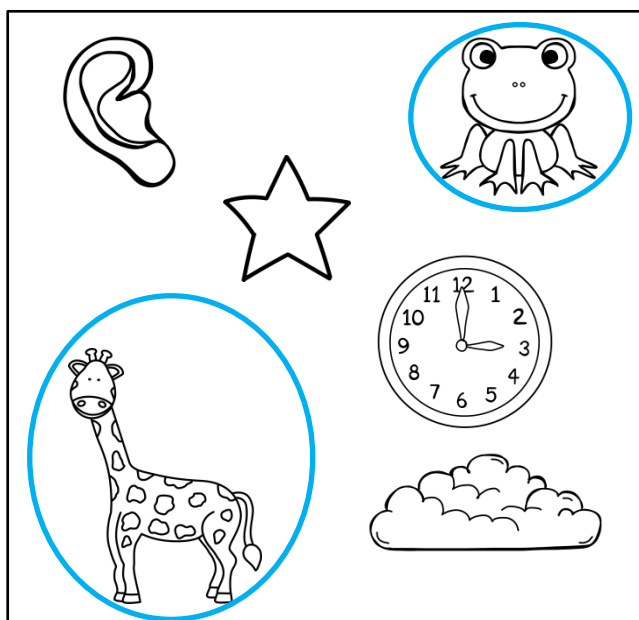

5 Означи бројевима 1,2,3

3	2	1
Зз	Жж	Ее

1 Обој

Зз

2 Допиши слово које недостаје

Ж	З	И
---	---	---

Ж	З	И
---	---	---

Ж	З	И
---	---	---

3 Повежи

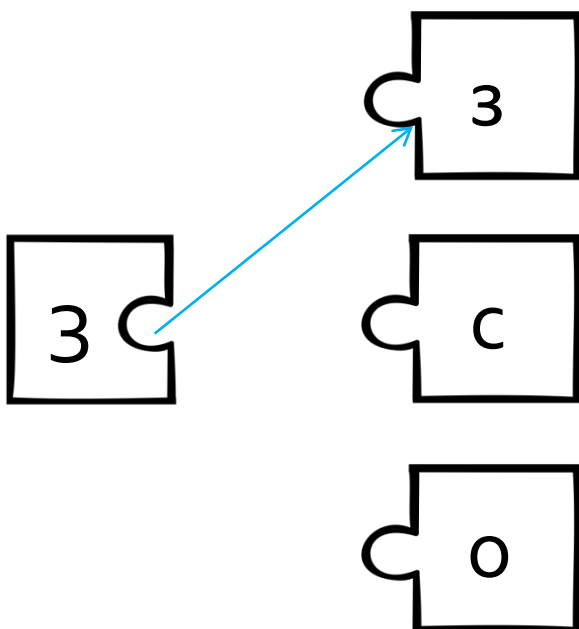

4 Обој слово з

з	с	з	с
с	з	з	с
с	з	с	с

6 Заокружи све што почиње на слово з

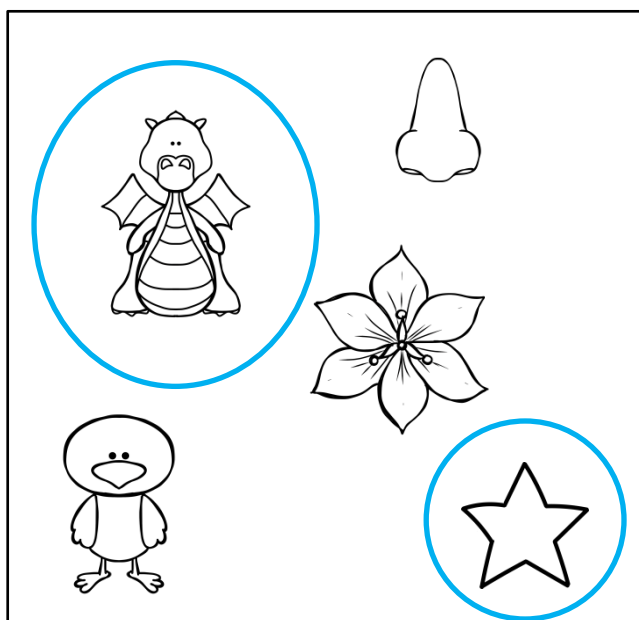

5 Означи бројевима 1,2,3

3	2	1
Ии	Зз	Жж

1 Обој

Ии

2 Допиши слово које недостаје

З	И	Ј
---	---	---

З	И	Ј
---	---	---

З	И	Ј
---	---	---

3 Повежи

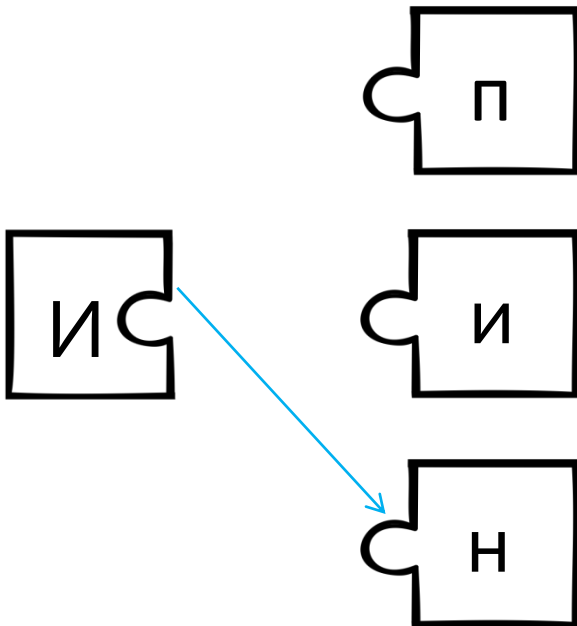

4 Обој слово и

И	И	Н	Н
Н	И	Н	И
И	Н		Н

6 Заокружи све што почиње на слово и

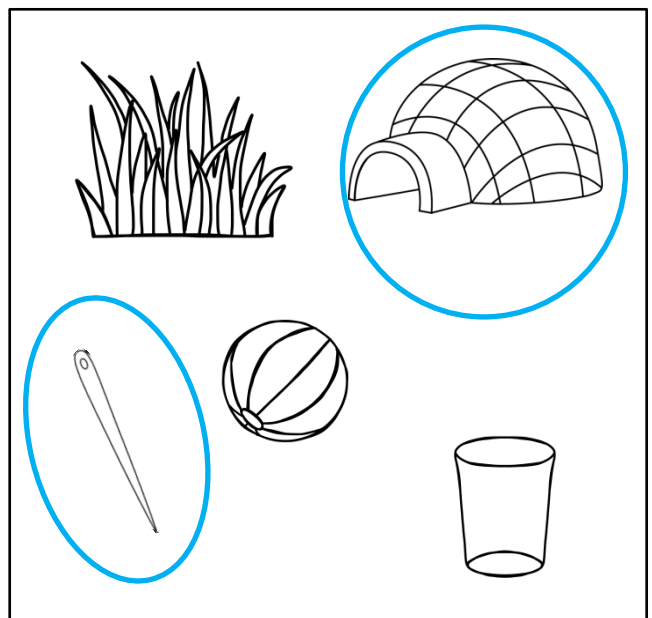

5 Означи бројевима 1,2,3

2	3	1
Ии	Јј	Зз

1 Обој

Jj

2 Допиши слово које недостаје

И	Ј	К
---	---	---

3 Повежи

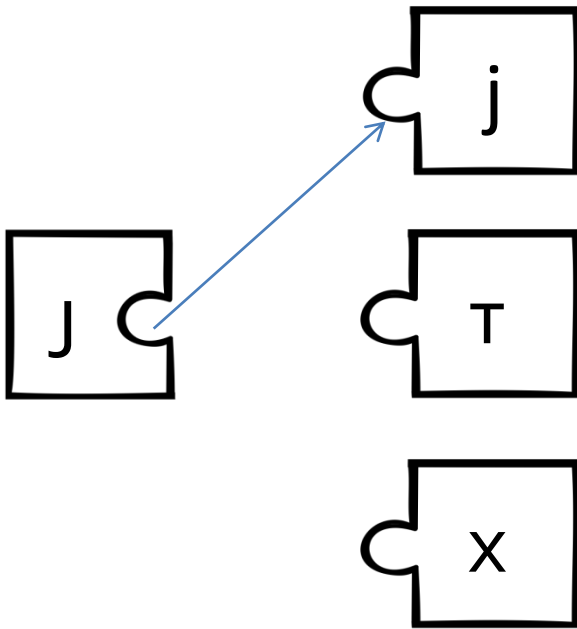

И	Ј	К
---	---	---

И	Ј	К
---	---	---

4 Обој слово ј

т	ј	т	т
т	ј	ј	т
ј	т	ј	т

6 Заокружи све што почиње на слово ј

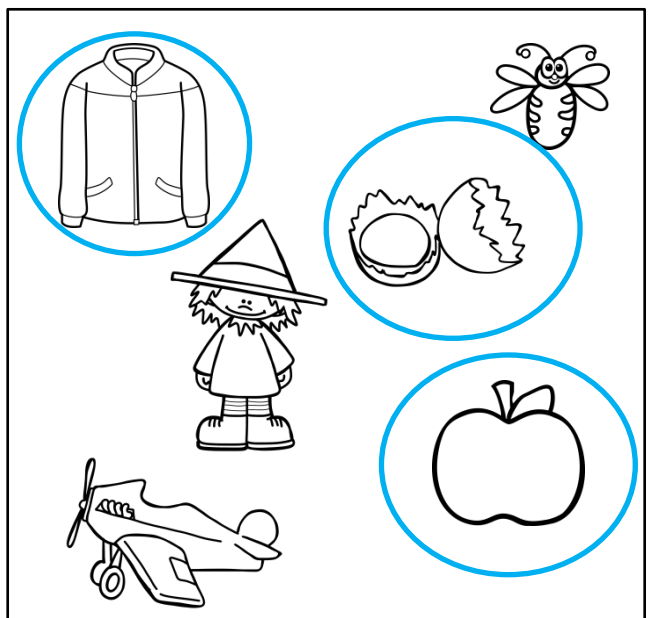

5 Означи бројевима 1,2,3

2	3	1
Jj	Кк	Ии

1 Обој

Кк

2 Допиши слово које недостаје

И	к	л
---	---	---

3 Повежи

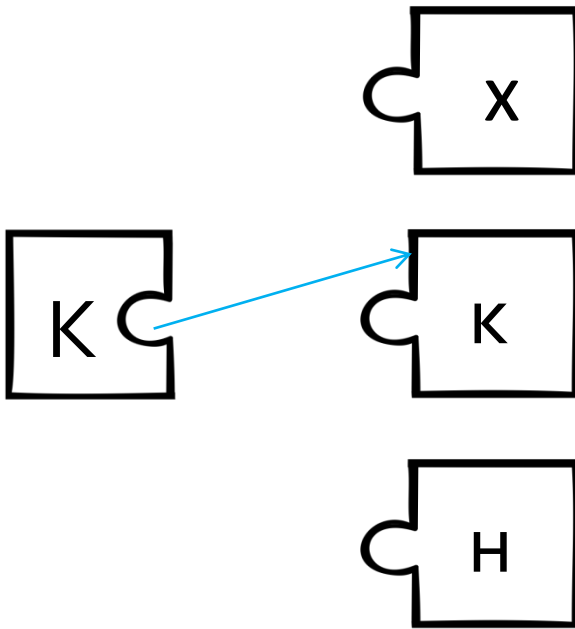

И	к	л
---	---	---

и	к	л
---	---	---

4 Обој слово к

к	х	к	х
х	х	к	к
к	х	х	к

6 Заокружи све што почиње на слово к

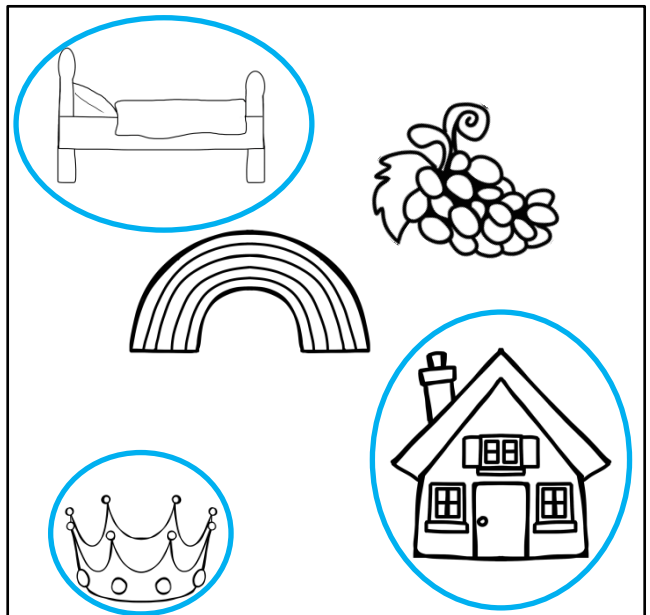

5 Означи бројевима 1,2,3

2	1	3
Кк	Ии	Лл

1 Обој

Лл

2 Допиши слово које недостаје

К	л	љ
---	---	---

К	л	љ
---	---	---

К	л	љ
---	---	---

3 Повежи

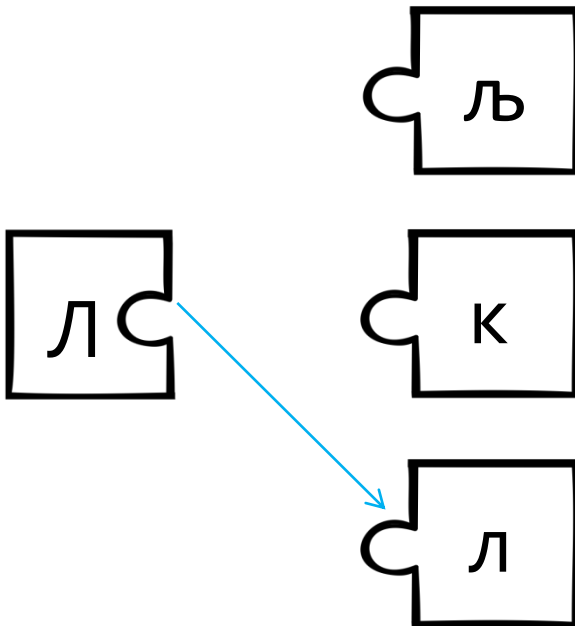

4 Обој слово Л

л	љ	л	љ
л	љ	љ	л
љ	л	л	љ

5 Означи бројевима 1,2,3

3	1	2
Љљ	Кк	Лл

6 Заокружи све што почиње на слово Л

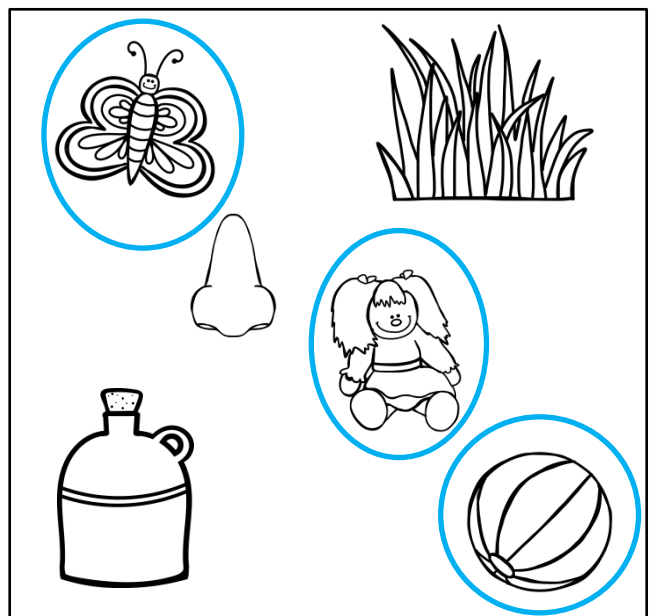

1 Обој

Љ љ

2 Допиши слово које недостаје

л	љ	м
---	---	---

л	љ	м
---	---	---

л	љ	м
---	---	---

3 Повежи

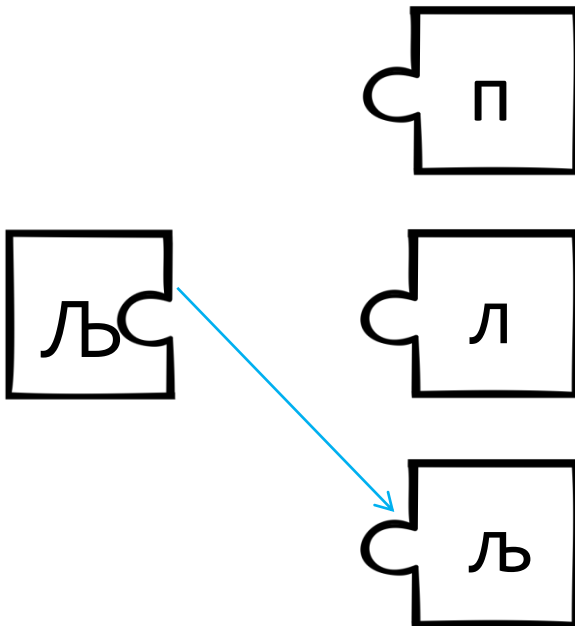

4 Обој слово љ

љ	љ	л	л
л	л	љ	л
л	л	л	љ

6 Заокружи све што почиње на слово љ

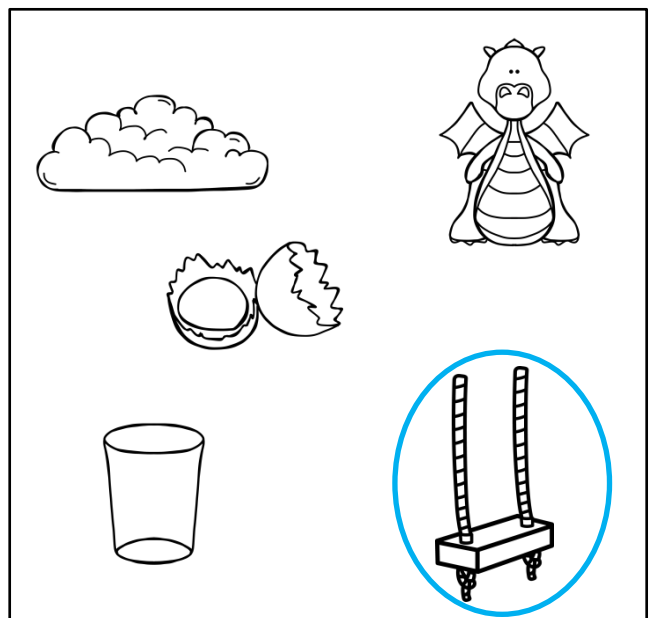

5 Означи бројевима 1,2,3

3	1	2
Мм	Лл	Љљ

1 Обој

ММ

2 Допиши слово које недостаје

Љ М Н

Љ М Н

Љ М Н

3 Повежи

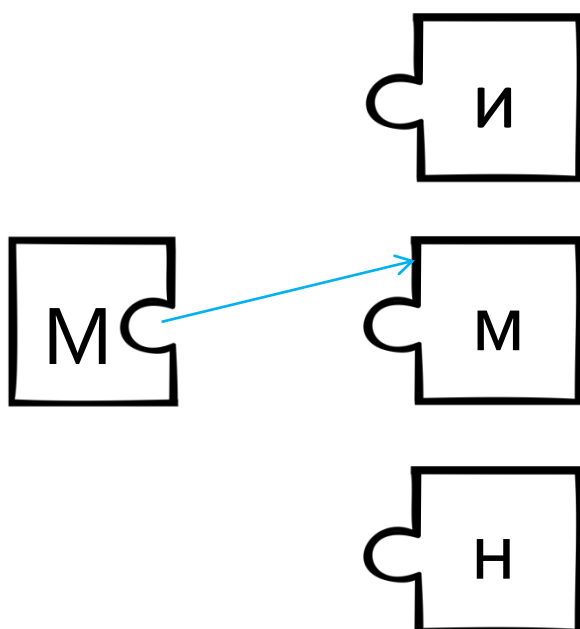

4 Обој слово м

М	Н	Н	М
Н	М	М	Н
М	Н	М	Н

5 Означи бројевима 1,2,3

2	3	1
Нн	Љљ	Мм

6 Заокружи све што почиње на слово м

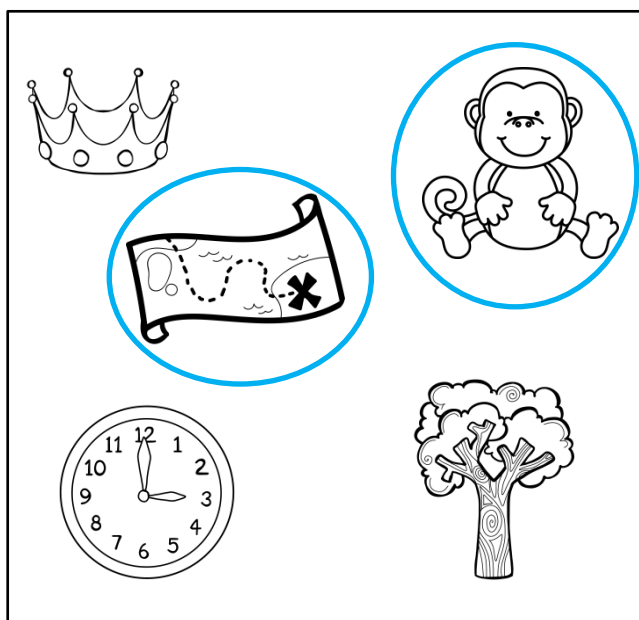

1 Обој

НН

2 Допиши слово које недостаје

М	Н	Њ
---	---	---

М	Н	Њ
---	---	---

М	Н	Њ
---	---	---

3 Повежи

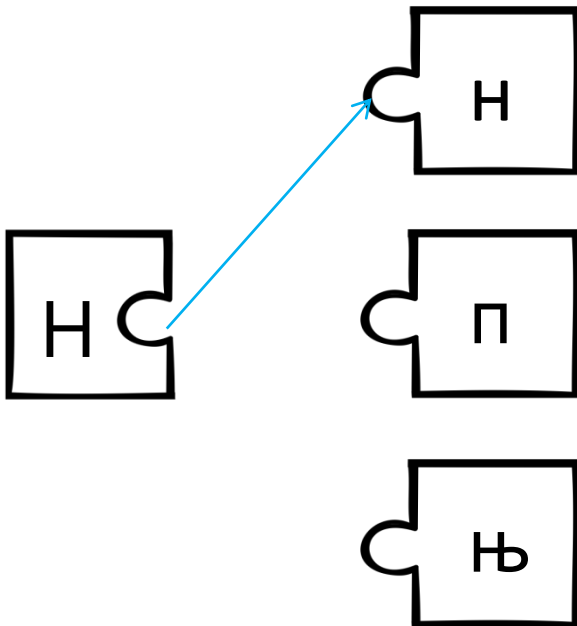

4 Обој слово н

Н	Њ	Н	Њ
Њ	Н	Н	Њ
Н	Њ	Њ	Н

5 Означи бројевима 1,2,3

2	1	3
НН	ММ	ЊЊ

6 Заокружи све што почиње на слово н

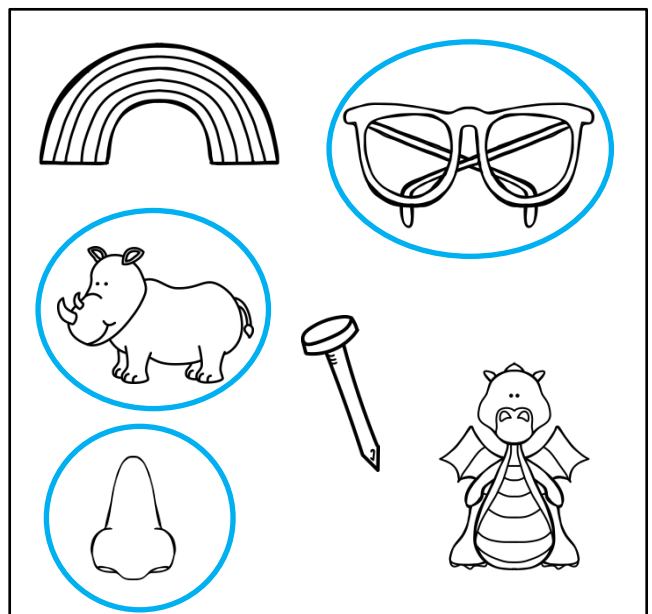

1 Обој

Њ њ

2 Допиши слово које недостаје

Н	Њ	О
---	---	---

Н	Њ	О
---	---	---

Н	Њ	О
---	---	---

3 Повежи

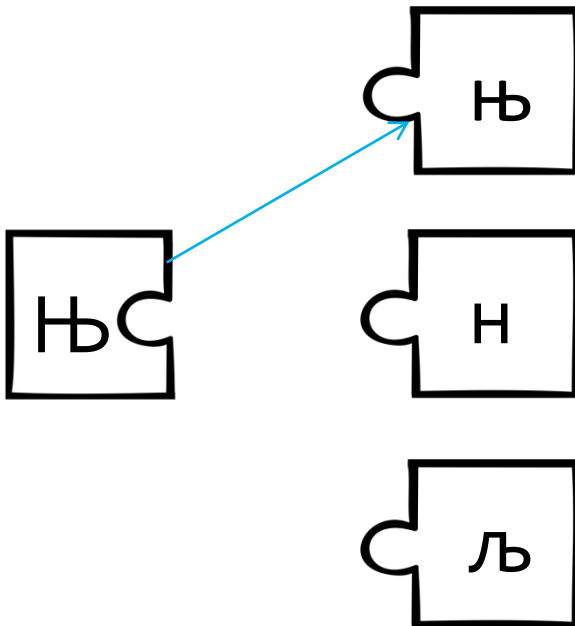

4 Обој слово њ

њ	љ	њ	љ
њ	њ	љ	љ
љ	њ	њ	њ

6 Заокружи све што почиње на слово њ

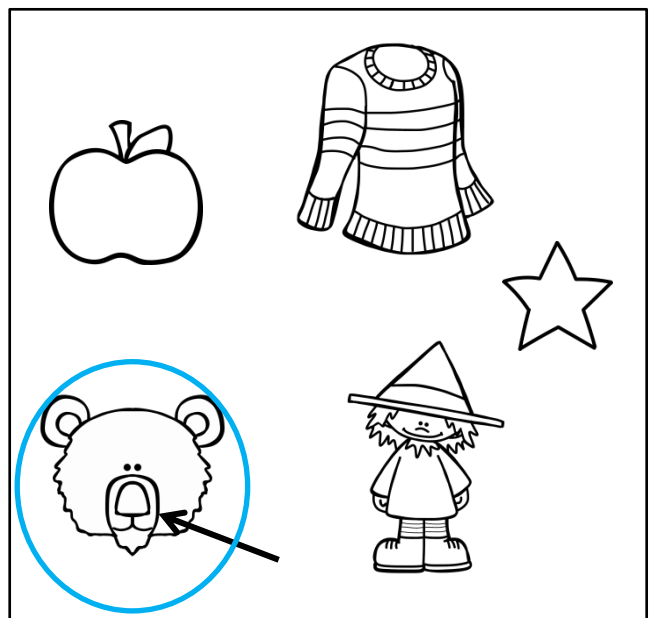

5 Означи бројевима 1,2,3

3	2	1
Оо	Њњ	Нн

1 Обој

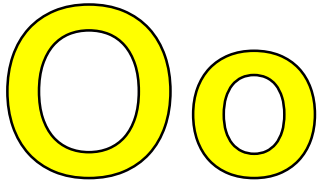

2 Допиши слово које недостаје

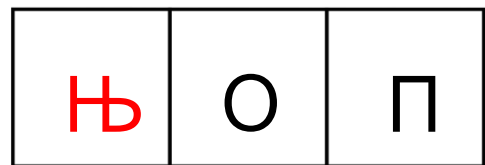
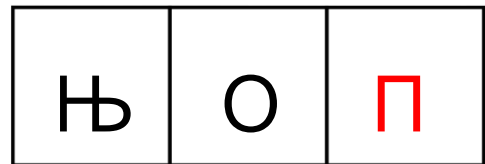
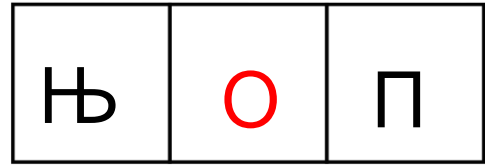

3 Повежи

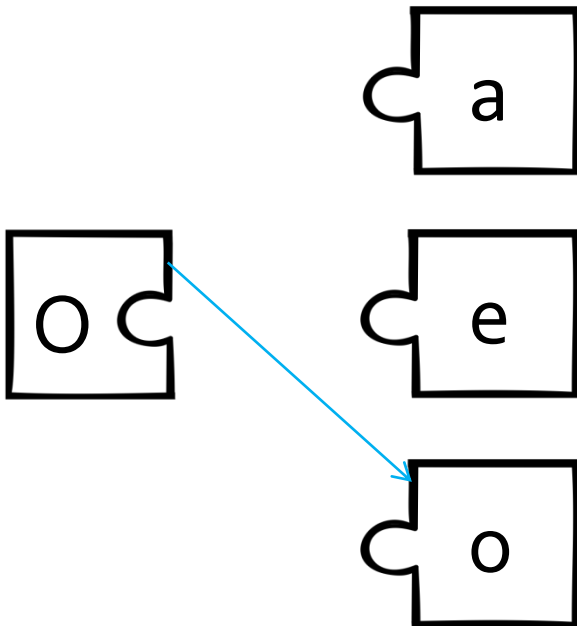

4 Обој слово о

а	о	а	о
а	о	о	а
о	о	о	а

6 Заокружи све што почиње на слово о

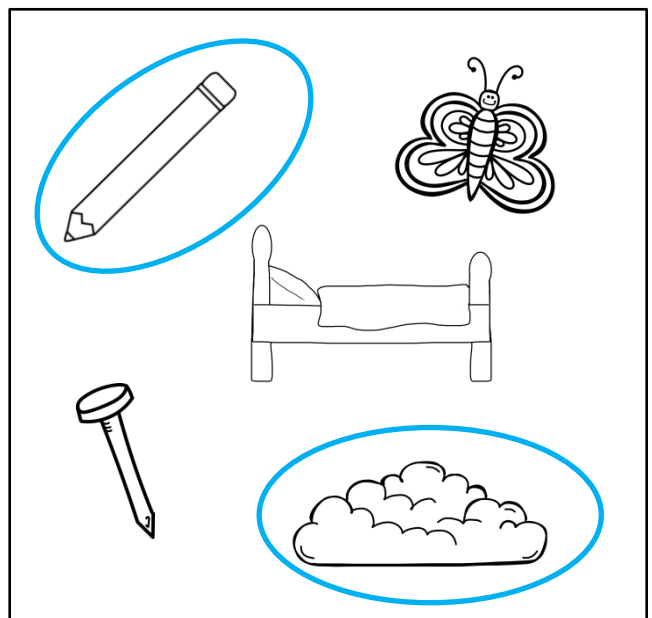

5 Означи бројевима 1,2,3

2	3	1
Пп	Њњ	Оо

1 Обој

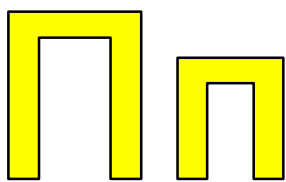

2 Допиши слово које недостаје

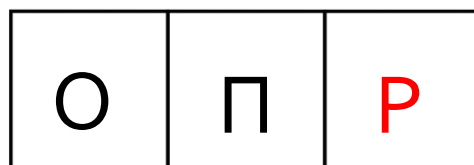
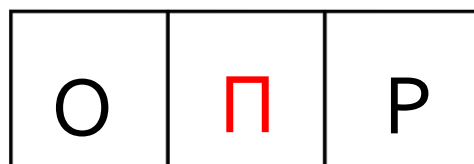
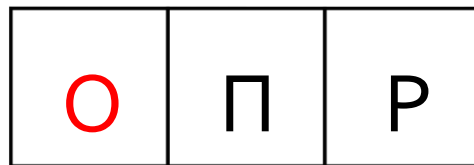

3 Повежи

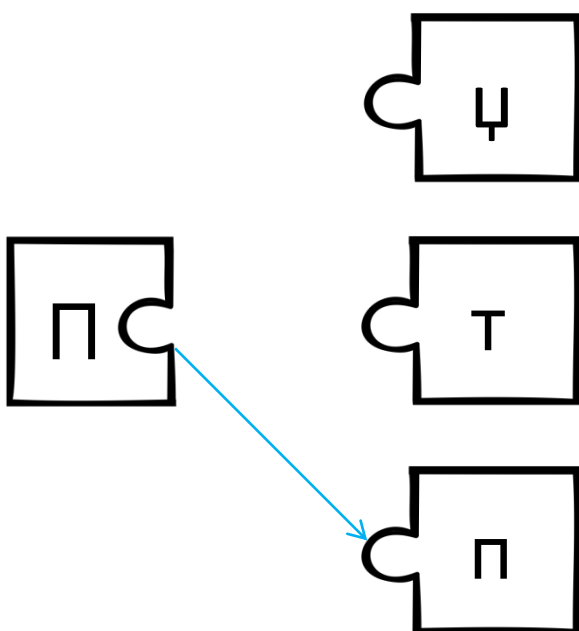

6 Заокружи све што почиње на слово п

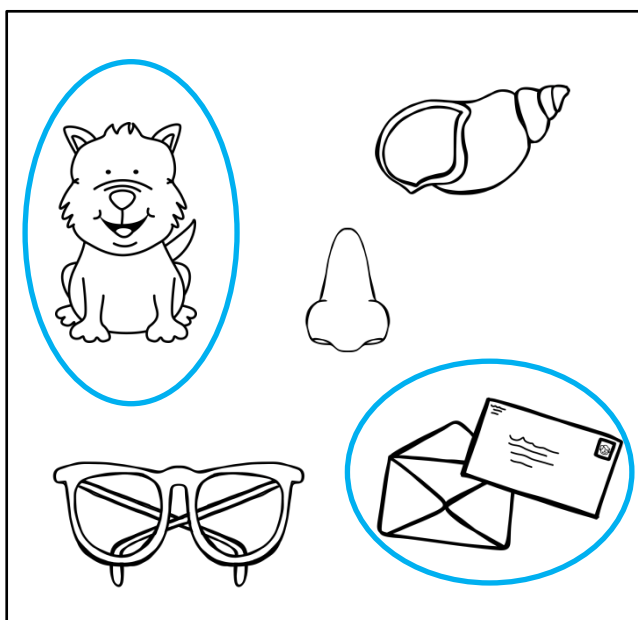

4 Обој слово п

п	п	т	т
т	п	п	т
п	т	п	т

5 Означи бројевима 1,2,3

2	3	1
Пп	Рр	Оо

1 Обој

Рр

2 Допиши слово које недостаје

п	р	с
---	---	---

п	р	с
---	---	---

п	р	с
---	---	---

3 Повежи

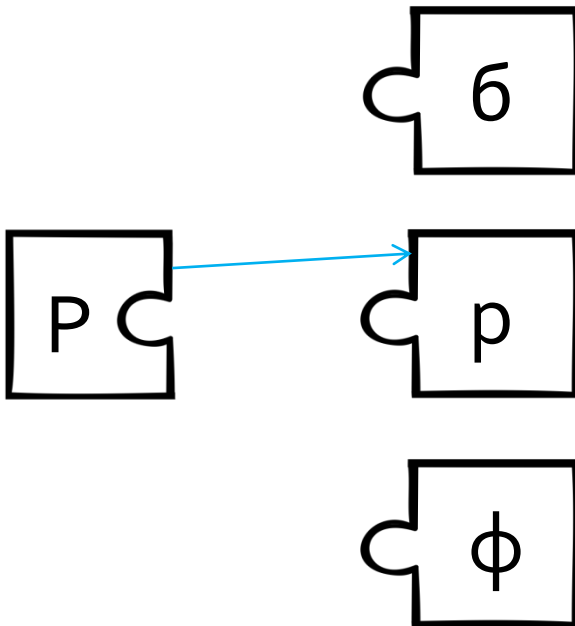

4 Обој слово р

б	р	р	б
р	б	р	б
б	б	р	р

6 Заокружи све што почиње на слово р

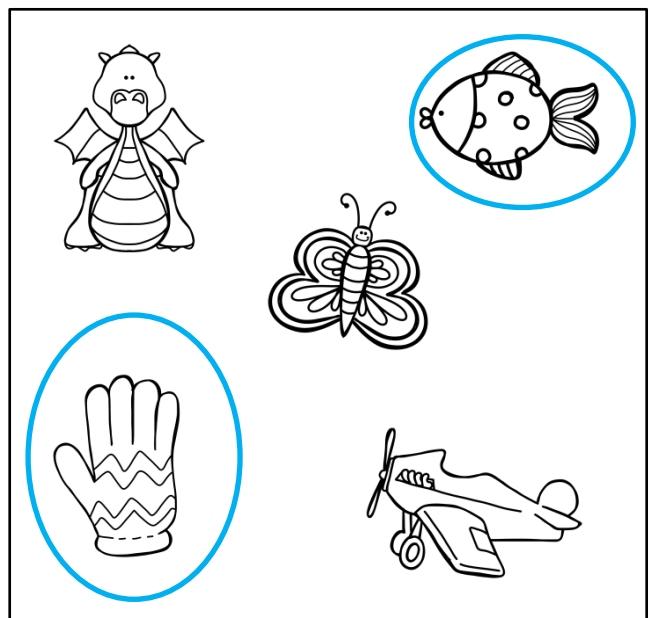

5 Означи бројевима 1,2,3

2	1	3
Рр	Пп	Сс

1 Обој

Сс

2 Допиши слово које недостаје

Р	С	Т
---	---	---

Р	С	Т
---	---	---

Р	С	Т
---	---	---

3 Повежи

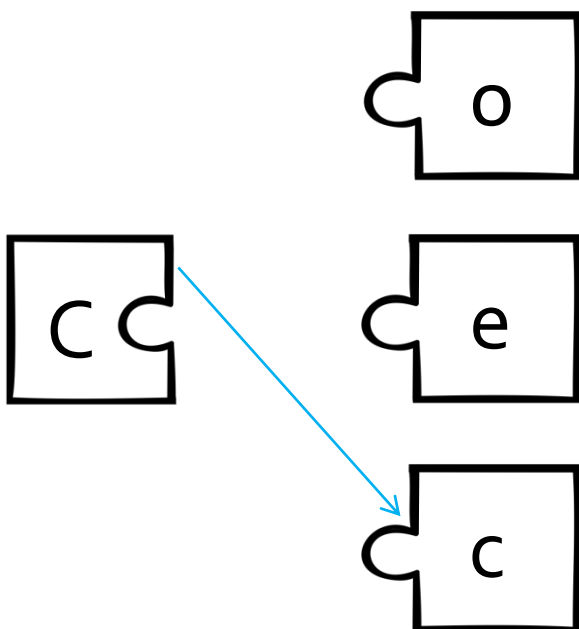

4 Обој слово с

о	с	о	с
с	о	о	с
с	с	о	о

6 Заокружи све што почиње на слово с

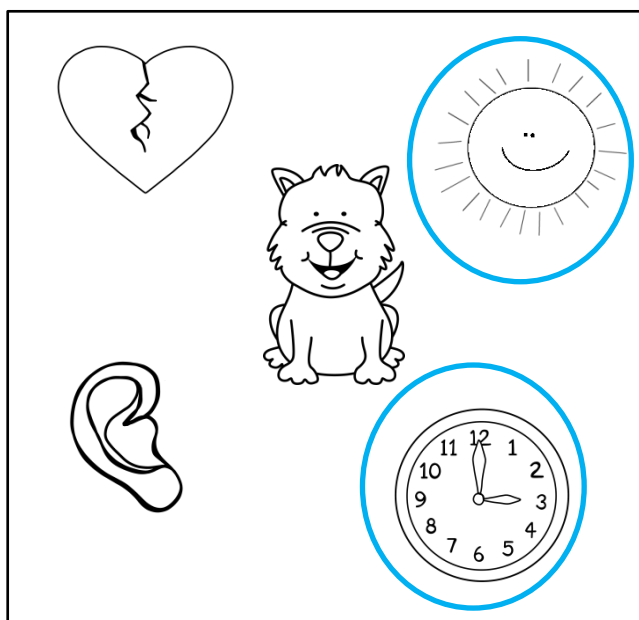

5 Означи бројевима 1,2,3

2	1	3
Сс	Рр	Тт

1 Обој

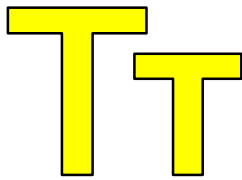

2 Допиши слово које недостаје

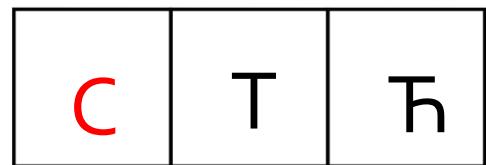
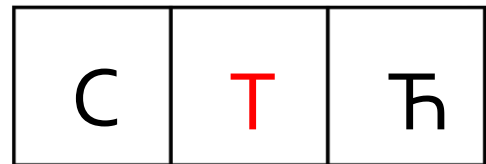
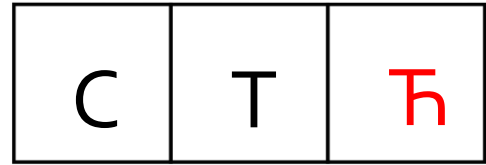

3 Повежи

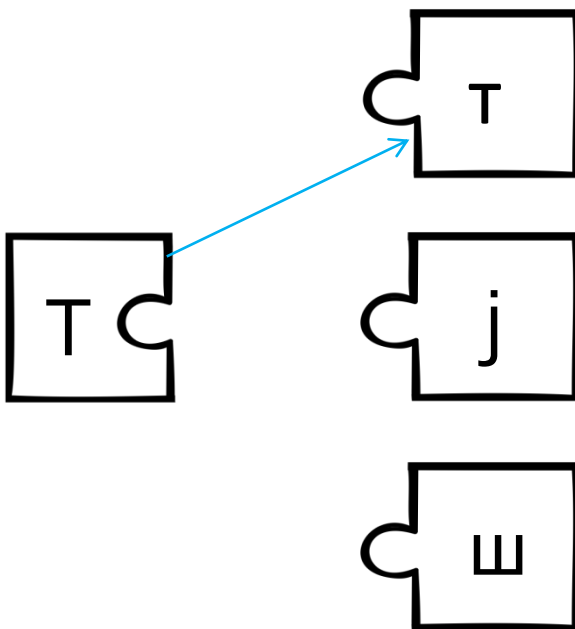

4 Обој слово т

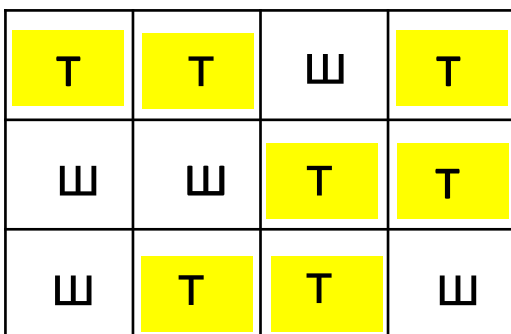

5 Означи бројевима 1,2,3

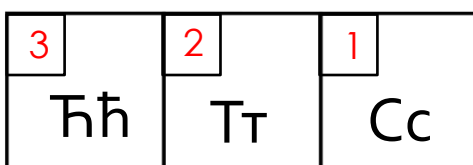

6 Заокружи све што почиње на слово т

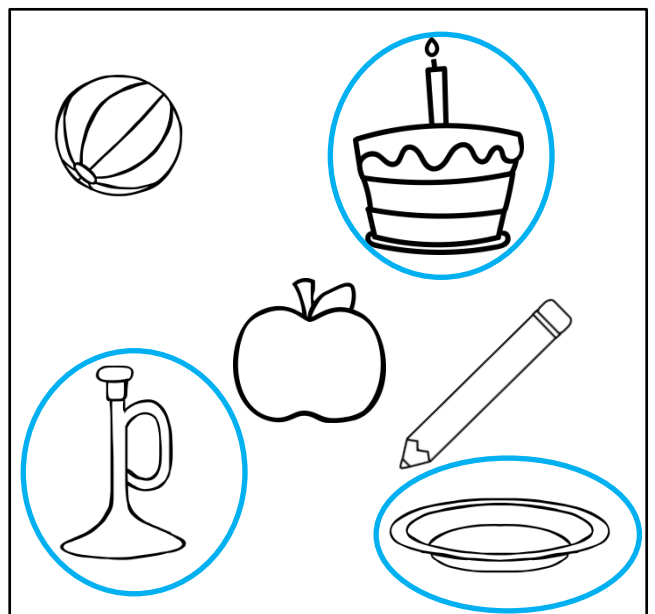

1 Обој

Ћћ

2 Допиши слово које недостаје

Т	Ћ	у
---	---	---

Т	Ћ	у
---	---	---

Т	Ћ	у
---	---	---

3 Повежи

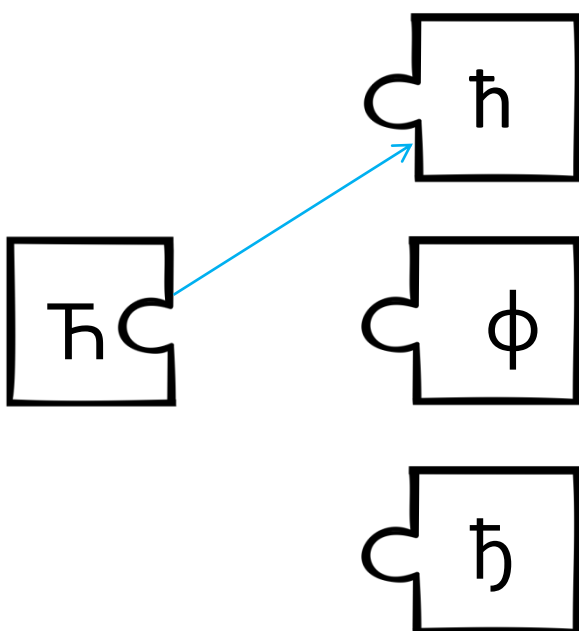

4 Обој слово ћ

ћ	ћ	ђ	ђ
ћ	ђ	ђ	ћ
ђ	ћ	ђ	ћ

5 Означи бројевима 1,2,3

1	3	2
Сс	Ћћ	Тт

6 Заокружи све што почиње на слово ћ

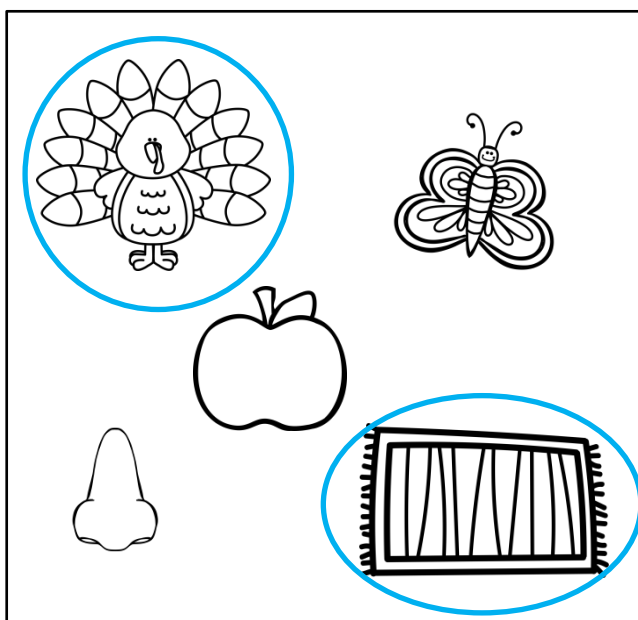

1 Обој

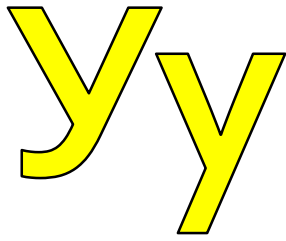

2 Допиши слово које недостаје

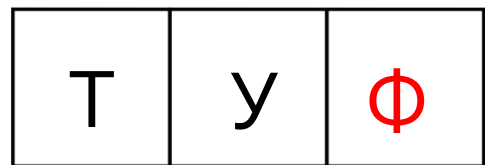
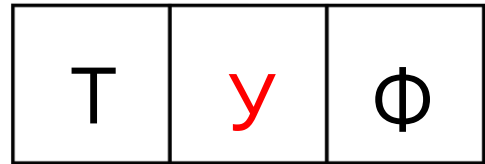
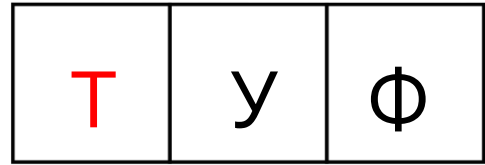

3 Повежи

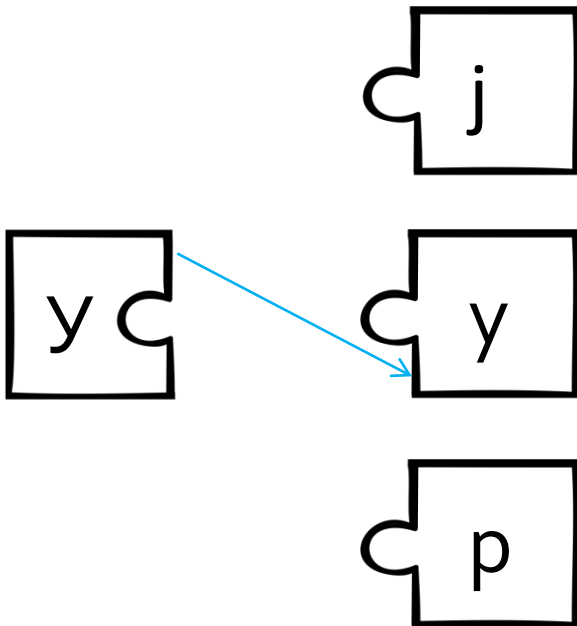

4 Обој слово у

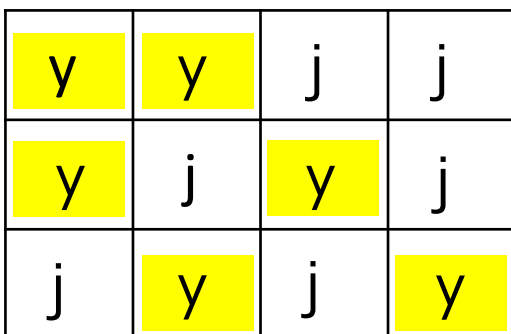

5 Означи бројевима 1,2,3

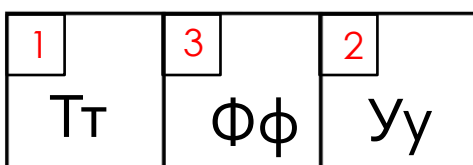

6 Заокружи све што почиње на слово у

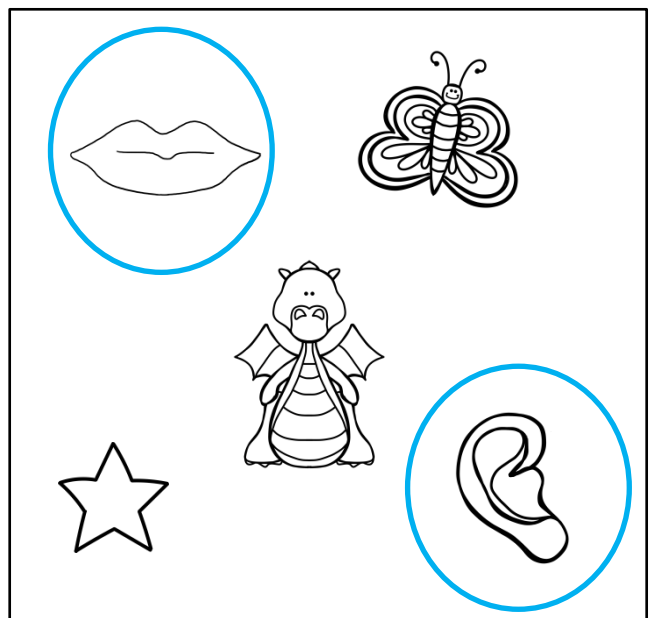

1 Обој

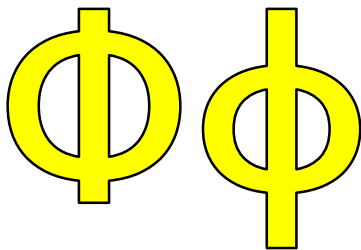

2 Допиши слово које недостаје

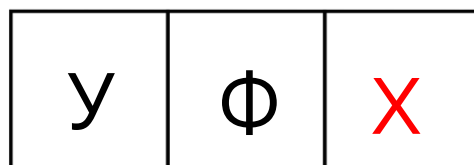
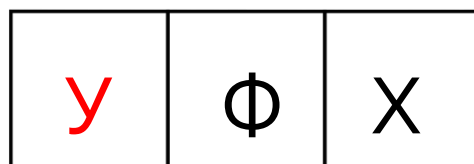
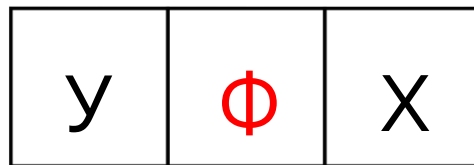

3 Повежи

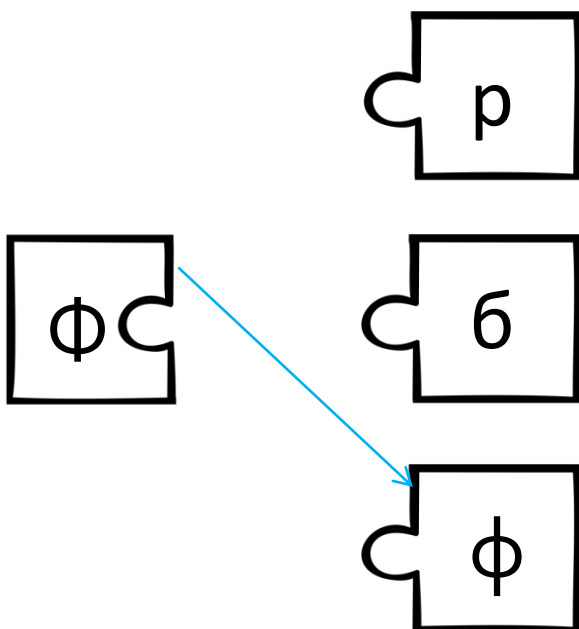

4 Обој слово ф

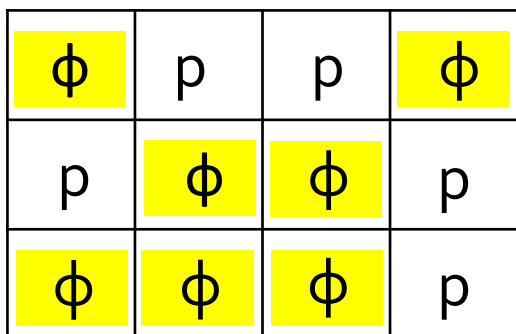

6 Заокружи све што почиње на слово ф

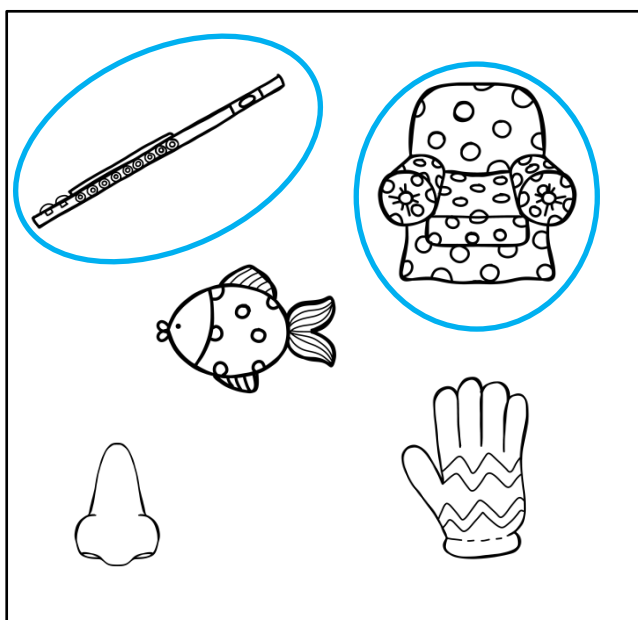

5 Означи бројевима 1,2,3

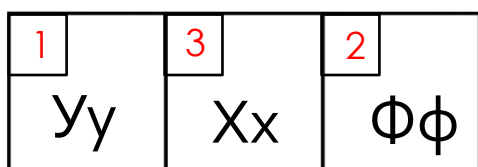

1 Обој

Xx

2 Допиши слово које недостаје

Ф	Х	Ц
---	---	---

Ф	Х	Ц
---	---	---

Ф	Х	Ц
---	---	---

3 Повежи

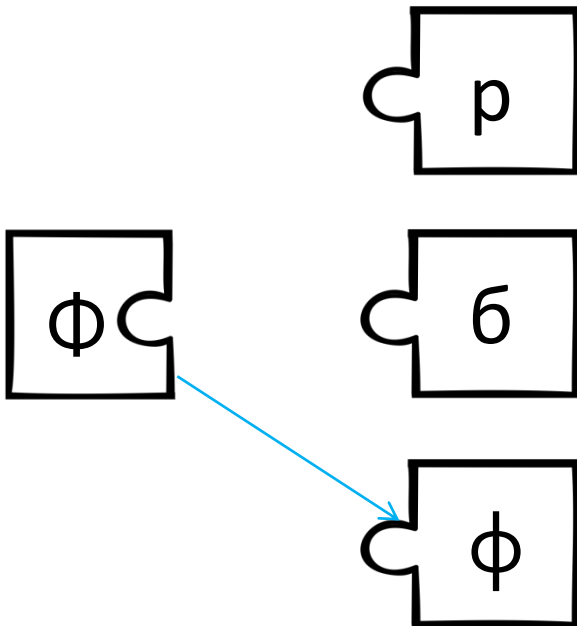

4 Обој слово х

х	ж	х	ж
ж	х	х	ж
ж	х	ж	х

6 Заокружи све што почиње на слово х

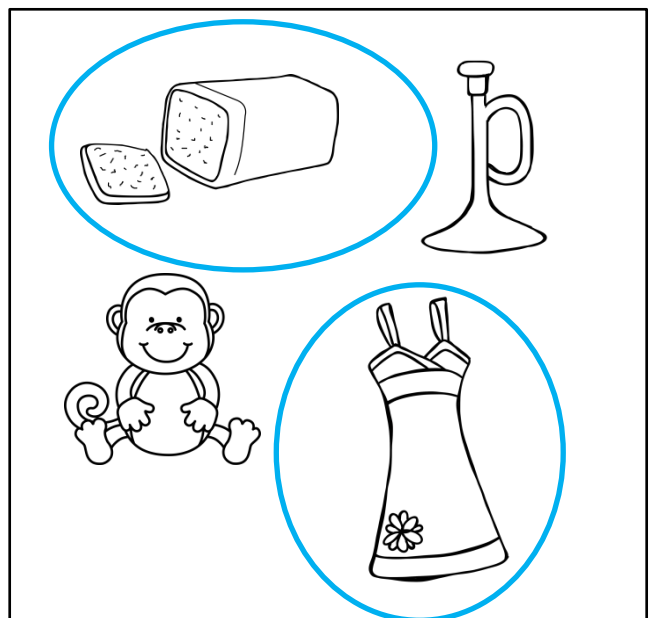

5 Означи бројевима 1,2,3

3	2	1
Цц	Хх	Фф

1 Обој

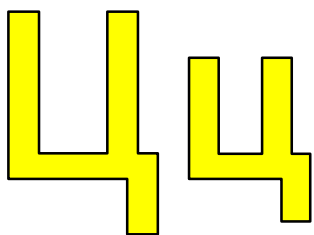

2 Допиши слово које недостаје

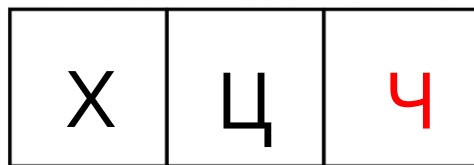
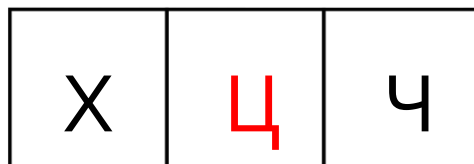
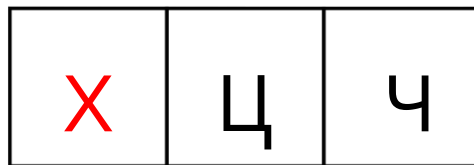

3 Повежи

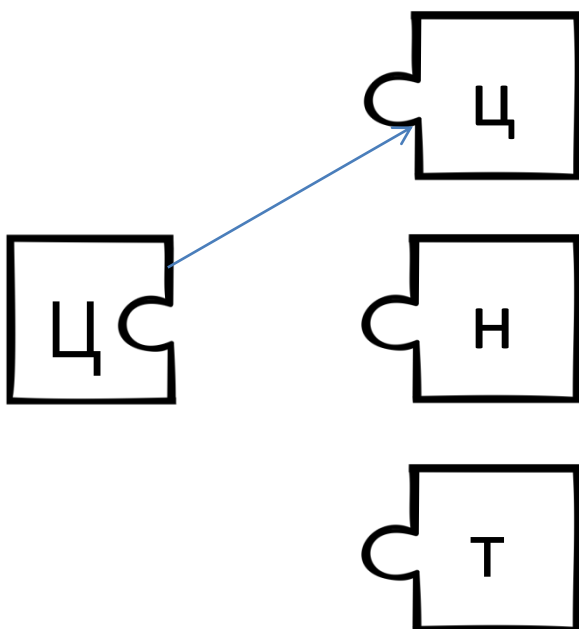

4 Обој слово ц

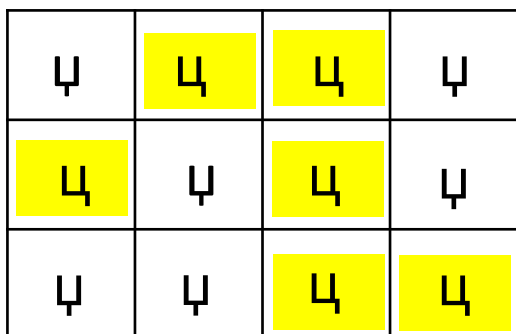

5 Означи бројевима 1,2,3

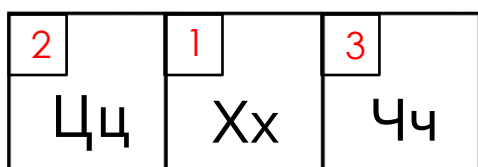

6 Заокружи све што почиње на слово ц

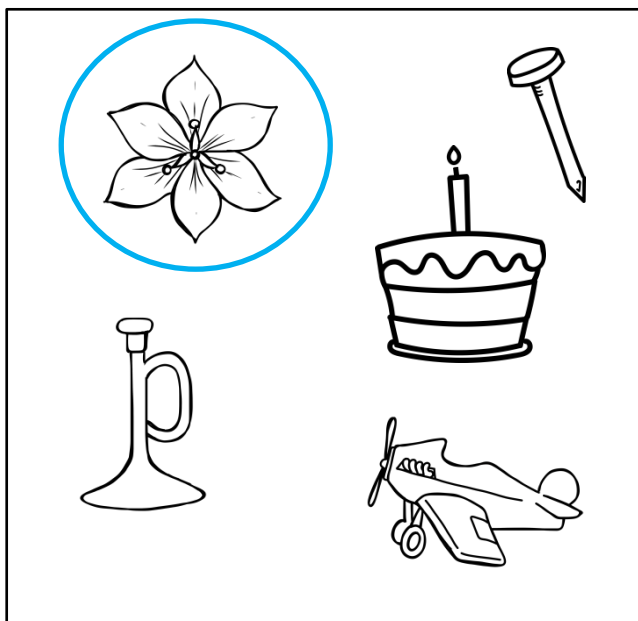

1 Обој

Чч

2 Допиши слово које недостаје

Ц	Ч	Џ
---	---	---

Ц	Ч	Џ
---	---	---

Ц	Ч	Џ
---	---	---

3 Повежи

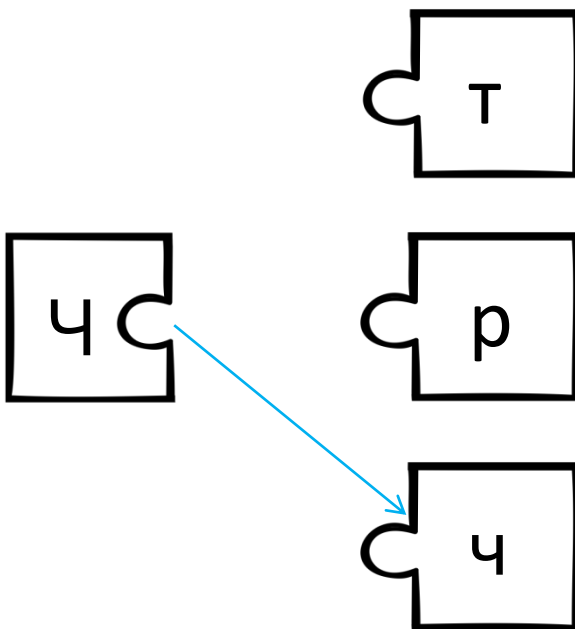

4 Обој слово ч

ч	р	ч	р
р	ч	ч	р
ч	ч	р	р

6 Заокружи све што почиње на слово ч

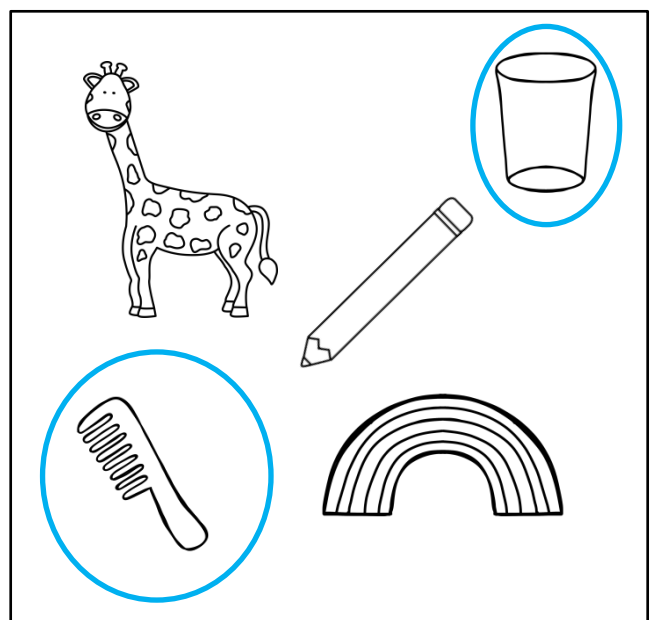

5 Означи бројевима 1,2,3

1	3	2
Цц	ЏЏ	Чч

1 Обој

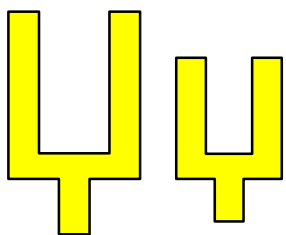

2 Допиши слово које недостаје

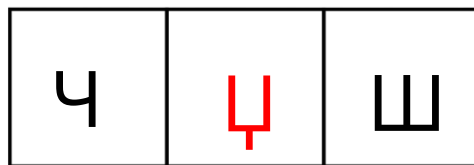
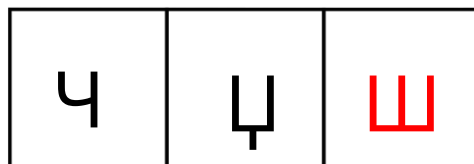
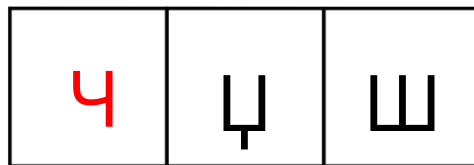

3 Повежи

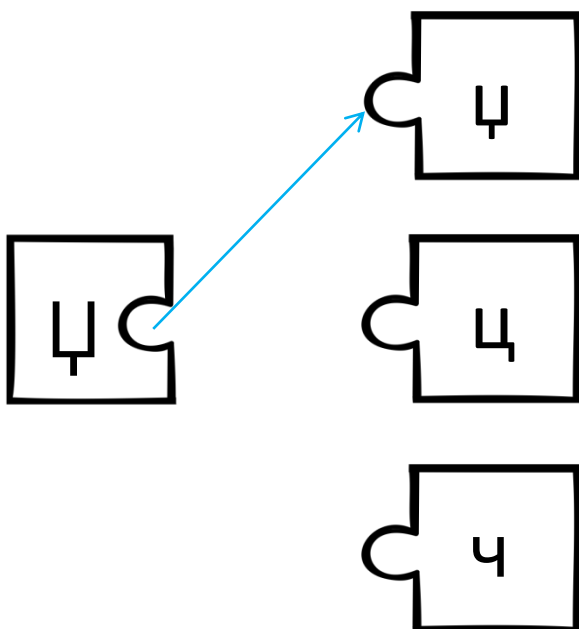

4 Обој слово ц

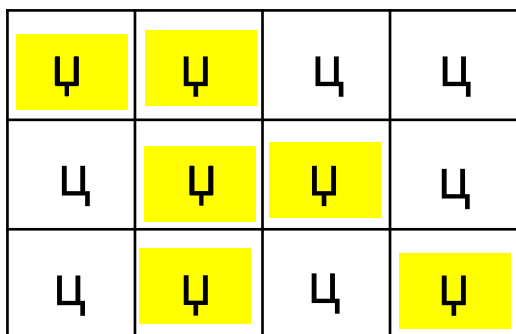

5 Означи бројевима 1,2,3

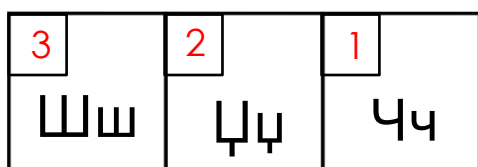

6 Заокружи све што почиње на слово ц

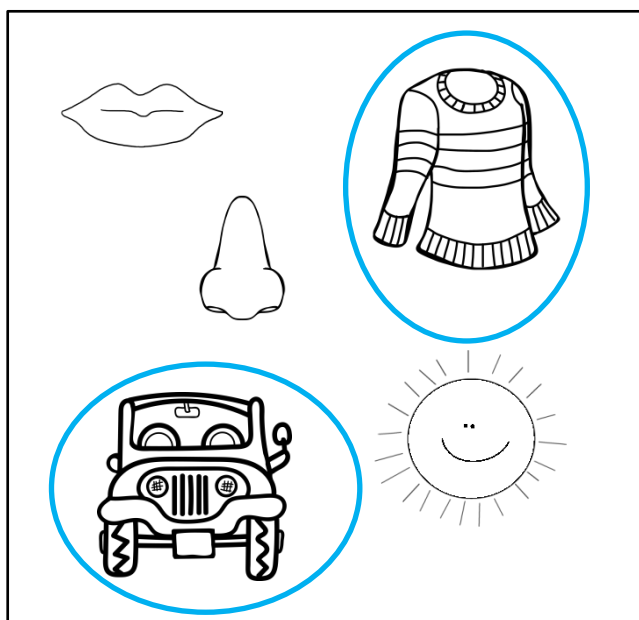

1 Обој

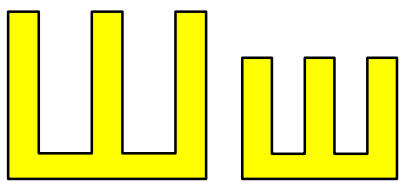

2 Допиши слово које недостаје

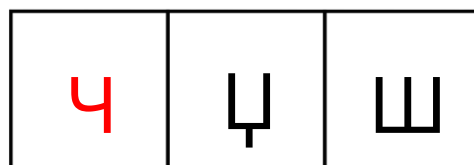
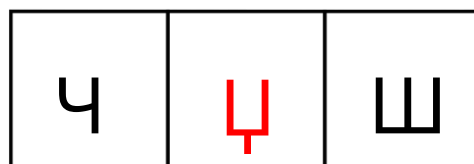
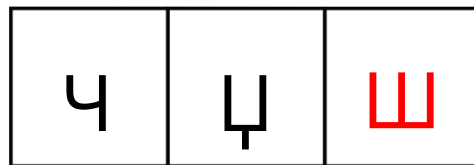

3 Повежи

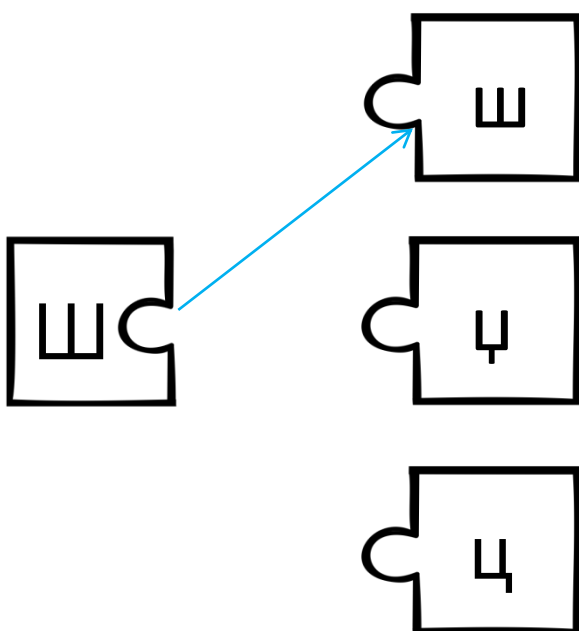

4 Обој слово ш

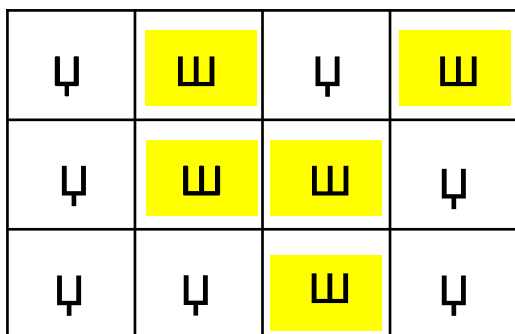

5 Означи бројевима 1,2,3

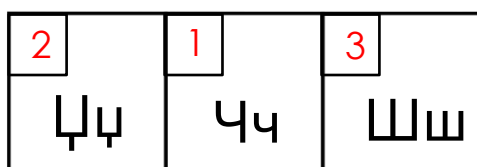

6 Заокружи све што почиње на слово ш

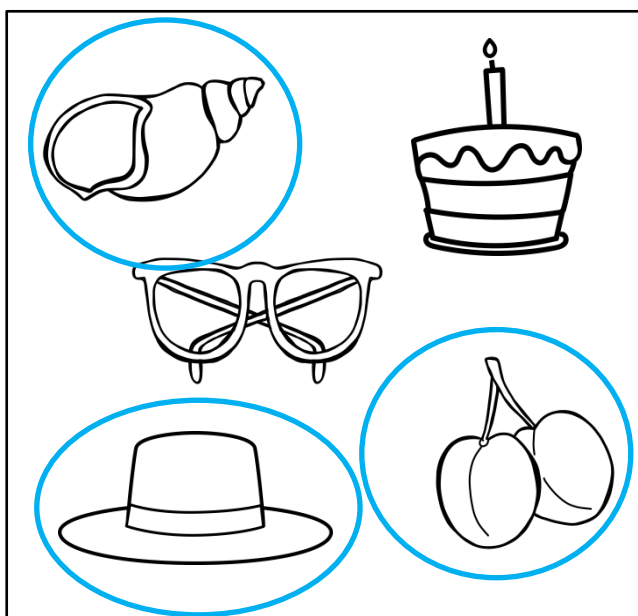

This product was created by



Terms of use

This product is licensed for personal and single classroom use only and may not be redistributed in part or whole without the written consent of the author. If your colleagues are interested in a copy, extra licenses are half off in my TpT store. Please contact me with any questions. Thank you very much for respecting my copyright! 😊

Special thanks and artist credit to:



David's Simple Teaching <https://www.teacherspayteachers.com/Store/Davids-Simple-Teaching>
<http://www.mycutegraphics.com/>